



ETA-Danmark A/S
Göteborg Plads 1
DK-2150 Nordhavn
Tel. +45 72 24 59 00
Fax +45 72 24 59 04
Internet www.etadanmark.dk

Autorisiert und notifiziert
gemäß Artikel 29 der Verordnung
(EU) Nr. 305/2011 des Euro-
päischen Parlaments und des
Rats der Europäischen Union
vom 9. März 2011

MITGLIED DER EOTA



Dies ist eine Übersetzung des englischsprachigen Original-
Dokumentes und wurde angefertigt von SPAX International
GmbH & Co KG. Bei Unklarheiten gilt das Original.

Europäische Technische Bewertung ETA-12/0114 vom 12.10.2017

I Allgemeiner Teil

Die ETA ausstellende technische Bewertungsstelle gemäß Artikel 29 der Verordnung (EU) Nr. 305/2011: ETA-Danmark A/S

Handelsname:

SPAX Schrauben

**Produktfamilie, zu der das
Bauprodukt gehört:**

Schrauben als Holzverbindungsmittel in tragenden
Holzkonstruktionen

Hersteller:

SPAX International GmbH & Co. KG
Kölner Strasse 71-77
DE-58256 Ennepetal
Tel. +49 23 33 799-0
Fax + 49 23 33 799-199
Internet www.spax.com

Herstellwerk:

SPAX International GmbH & Co. KG
Kölner Strasse 71-77
DE-58256 Ennepetal

**Diese Europäische Technische
Bewertung enthält:**

101 Seiten einschließlich 5 Anhänge, die fester Bestandteil
dieses Dokuments sind

**Diese Europäische Technische
Bewertung wird gemäß der
Verordnung (EU) Nr. 305/2011
auf der Grundlage des**

Europäischen Bewertungsdokuments (EAD) Nr. EAD
130118-00-0603 "Schrauben als Holzverbindungsmittel"
ausgestellt.

Diese Version ersetzt:

die vorherige ETA mit derselben Nummer ausgestellt am
10.07.2017

Übersetzungen dieser Europäischen Technischen Bewertung in andere Sprachen müssen dem Original vollständig entsprechen und müssen als solche gekennzeichnet sein. Diese Europäische Technische Bewertung darf, auch bei elektronischer Übermittlung, nur vollständig und ungekürzt wiedergegeben werden (ausgenommen die oben genannten vertraulichen Anhänge). Nur mit schriftlicher Zustimmung der ausstellenden Technischen Bewertungsstelle kann eine teilweise Wiedergabe erfolgen. Jede teilweise Wiedergabe ist als solche zu kennzeichnen.

II SPEZIFISCHER TEIL DER EUROPÄISCHEN TECHNISCHEN BEWERTUNG

1 Technische Beschreibung des Produkts und des Verwendungszwecks

Technische Beschreibung des Produkts:

SPAX Schrauben sind selbstbohrende Schrauben als Holzverbindungsmitel in tragenden Holzkonstruktionen. Sie haben ein Teil- oder Vollgewinde. SPAX Gewindestangen haben ein Vollgewinde. Aus Kohlenstoffstahldraht gefertigte Schrauben werden mit einem Nenndurchmesser von 2,5 mm bis 12,0 mm, Schrauben aus rostfreiem Stahldraht mit einem Nenndurchmesser von 3,0 mm bis 12,0 mm hergestellt. SPAX Gewindestangen werden aus Kohlenstoffstahldraht oder aus rostfreiem Stahldraht mit einem Nenndurchmesser von 16,0 mm hergestellt. Ist Korrosionsschutz erforderlich, so muss das Material bzw. die Beschichtung mit den in Anhang A der EN 14592 angeführten relevanten Spezifikationen übereinstimmen.

Geometrie und Material

Der Nenndurchmesser (Gewindeaußendurchmesser), d , von SPAX Schrauben darf nicht kleiner als 2,5 mm und nicht größer als 12,0 mm sein. Der Nenndurchmesser von SPAX Gewindestangen beträgt 16 mm. Die Gesamtlänge der Schrauben, ℓ , darf nicht kürzer als 20 mm und nicht länger als 1000 mm sein. Die Gesamtlänge der Gewindestangen, ℓ , darf nicht größer als 3000 mm sein. Die sonstigen Maße sind in Anhang A angegeben.

Das Verhältnis des Kerndurchmessers zum Gewindeaußendurchmesser, d_i/d , reicht von 0,58 bis 0,68.

Die Schrauben haben eine Mindestgewindelänge ℓ_g von $4 \cdot d$ (i.e. $\ell_g \geq 4 \cdot d$).

Die Gewindestange p (Abstand zwischen zwei angrenzenden Gewindegängen) reicht von $0,49 \cdot d$ bis $0,61 \cdot d$.

Die Schrauben müssen ohne abzuscheren um einen Winkel α von $(45/d^{0,7} + 20)$ Grad biegsam sein.

2 Spezifizierung des Verwendungszwecks gemäß dem anwendbaren EAD

Die Schrauben und Gewindestangen sind für die Verwendung in tragenden Holzkonstruktionen zur Verbindung von Teilen aus Vollholz (Nadelholz), Brettschichtholz (Nadelholz), Brettsperrholz, Furnierschichtholz LVL (Nadelholz), ähnlich verleimten Holzbauteilen, Holzwerkstoffplatten oder von Stahlteilen bestimmt. Die Schrauben sind außerdem für die Verwendung in tragenden Teilen aus Vollholz (Laubholz), Brettschichtholz (Laubholz) oder Furnierschichtholz LVL (Laubholz) bestimmt. Zudem können SPAX Schrauben mit Vollgewinde und SPAX Gewindestangen auch als Zug- oder Druckbewehrung quer zur Faser oder als Schubbewehrung in Holzteilen aus Nadelholz verwendet werden.

SPAX Schrauben mit Durchmessern zwischen 6 mm und 12 mm können auch zur Befestigung von Wärmedämmmaterialien auf Sparren verwendet werden.

Stahlplatten und Holzwerkstoffplatten dürfen, mit Ausnahme von Vollholzplatten, Furnierschichtholzplatten LVL und Brettsperrholzplatten, nur schraubenkopfseitig angebracht werden.

Es können die nachstehenden Holzwerkstoffe verwendet werden:

- Sperrholz gemäß EN 636 oder Europäischer Technischer Bewertung oder den am Installationsort geltenden nationalen Bestimmungen
- Pressspanplatten gemäß EN 312 oder Europäischer Technischer Bewertung oder den am Installationsort geltenden nationalen Bestimmungen
- OSB-Platten gemäß EN 300 oder Europäischer Technischer Bewertung oder den am Installationsort geltenden nationalen Bestimmungen
- Faserplatten gemäß EN 622-2 und 622-3 oder Europäischer Technischer Bewertung (Mindestrohddichte 650 kg/m^3) oder den am Installationsort geltenden nationalen Bestimmungen
- Zementgebundene Spanplatten gemäß EN 634 oder Europäischer Technischer Bewertung oder den am Installationsort geltenden nationalen Bestimmungen
- Vollholzplatten gemäß EN 13353 oder Europäischer Technischer Bewertung oder den am Installationsort geltenden nationalen Bestimmungen
- Brettsperrholzplatten gemäß Europäischer Technischer Bewertung
- Furnierschichtholzplatten LVL gemäß EN 14374 oder Europäischer Technischer Bewertung
- Holzwerkstoffe gemäß Europäischer Technischer Bewertung

Die Schrauben oder Gewindestangen sind für Holzverbindungen vorgesehen, die die Anforderungen an mechanische Beständigkeit, Stabilität und Nutzungssicherheit im Sinne der grundlegenden Anforderungen 1 und 4 der Verordnung 305/2011 (EU) des Rates erfüllen.

Die Bemessung der Verbindungen muss auf den charakteristischen Tragfähigkeiten der Schrauben basieren. Die Tragfähigkeiten sind von den charakteristischen Werten gemäß Eurocode 5 oder einer entsprechenden nationalen Norm abzuleiten.

Die Schrauben oder Gewindestangen sind für die Verwendung in Verbindungen mit ruhender oder vorwiegend ruhender Belastung vorgesehen.

Die verzinkten Schrauben und Gewindestangen sind für die Verwendung in Holzkonstruktionen unter trockenen Innenraumbedingungen gemäß den Nutzungsklassen 1 und 2 EN 1995-1-1:2008 (Eurocode 5). Die Schrauben und Gewindestangen aus rostfreiem Stahl erfüllen die Anforderungen des Eurocode 5 (EN 1995-1-1:2008) für die Verwendung in Konstruktionen unter feuchten Bedingungen gemäß Nutzungsklasse 3.

Die Bestimmungen dieser Europäischen Technischen Bewertung basieren auf einer angenommenen Nutzungsdauer der Schrauben von 50 Jahren.

Die Information zur Nutzungsdauer ist nicht als eine Garantie des Herstellers oder der die ETA ausstellenden Bewertungsstelle anzusehen, sondern soll nur als Richtlinie für die Auswahl der richtigen Produkte im Verhältnis zur erwarteten wirtschaftlichen Nutzungsdauer der Konstruktion dienen.

3 Leistung des Produkts und Angaben zu den angewandten Bewertungsmethoden

Merkmal	Beurteilung des Merkmals	
3.1 Mechanische Beständigkeit und Stabilität*) (BWR1)		
Zugtragfähigkeit	Charakteristischer Wert $f_{\text{tens,k}}$:	
Schrauben aus Kohlenstoffstahl	d = 2,5 mm:	1,8 kN
	d = 3,0 mm:	2,6 kN
	d = 3,5 mm:	3,8 kN
	d = 4,0 mm:	5,0 kN
	d = 4,5 mm oder 4,6 mm:	6,4 kN
	d = 5,0 mm:	7,9 kN
	d = 5,6 mm:	9,9 kN
	d = 6,0 mm:	11 kN
	d = 7,0 mm:	13 kN
	d = 8,0 mm:	17 kN
	d = 10,0 mm:	28 kN
	d = 12,0 mm:	38 kN
Gewindestangen aus Kohlenstoffstahl oder rostfreiem Stahl	d = 16,0 mm:	63 kN
Schrauben aus rostfreiem Stahl	d = 3,0 mm:	2,1 kN
	d = 3,5 mm:	2,9 kN
	d = 4,0 mm:	3,8 kN
	d = 4,5 mm oder 4,6 mm:	4,2 kN
	d = 5,0 mm oder 5,2 mm:	4,9 kN
	d = 5,6 mm:	6,2 kN
	d = 6,0 mm:	7,1 kN
	d = 7,0 mm:	10 kN
	d = 8,0 mm:	13 kN
	d = 10,0 mm:	20 kN
	d = 12,0 mm: :	28 kN
Einschraubdrehmoment	Verhältnis des charakteristischen Werts der Torsionsfestigkeit zum mittleren Einschraubdrehmoment: $f_{\text{tor,k}} / R_{\text{tor,mean}} \geq 1,5$	
Torsionsfestigkeit	Charakteristischer Wert $f_{\text{tor,k}}$:	
Schrauben aus Kohlenstoffstahl	d = 2,5 mm:	0,65 Nm
	d = 3,0 mm:	1,3 Nm
	d = 3,5 mm:	2,0 Nm
	d = 4,0 mm:	3,0 Nm
	d = 4,0 mm:	4,0 Nm
	d = 4,5 mm oder 4,6 mm:	6,0 Nm
	d = 5,0 mm:	8,0 Nm
	d = 5,6 mm:	10,5 Nm
	d = 6,0 mm:	14,2 Nm
	d = 7,0 mm:	21 Nm
	d = 8,0 mm:	40 Nm
	d = 10,0 mm:	70 Nm
	d = 12,0 mm:	
Schrauben aus rostfreiem Stahl	d = 3,0 mm:	1,0 Nm
	d = 3,5 mm:	1,7 Nm
	d = 4,0 mm:	2,4 Nm
	d = 4,5 mm oder 4,6 mm:	3,2 Nm
	d = 5,0 mm oder 5,2 mm:	4,6 Nm
	d = 5,6 mm:	5,6 Nm
	d = 6,0 mm:	7,0 Nm
	d = 7,0 mm:	8,7 Nm
	d = 8,0 mm:	17 Nm
	d = 10 mm:	28 Nm
	d = 12 mm:	54 Nm

Merkmal	Beurteilung des Merkmals
3.2 Sicherheit im Brandfall (BWR2)	
Brandverhalten	Die Schrauben bestehen aus Stahl der Leistungsklasse A1 des charakteristischen Brandverhaltens gemäß den Bestimmungen der delegierten Verordnung 2016/364 der Kommission und EU-Beschluss 96/603/EC, geändert durch EU-Beschluss 2000/605/EC.
3.3 Hygiene, Gesundheit und Umwelt (BWR3)	
Beeinflussung der Luftqualität	Das Produkt enthält / setzt keine gefährlichen Stoffe frei, wie in der TR 034, Fassung Oktober 2015, spezifiziert *
3.4 Gebrauchssicherheit (BWR4)	Siehe von BWR1 abgedeckte Aspekte
3.7 Nachhaltige Nutzung der natürlichen Ressourcen (BWR7)	Keine Leistung festgestellt
3.8 Allgemeine Aspekte hinsichtlich der Leistung des Produkts	Die Schrauben weisen bei der Verwendung in Holzkonstruktionen, in denen Holzarten gemäß Eurocode 5 und den Vorgaben der Nutzungsklassen 1, 2 und 3 zum Einsatz kommen, eine zufriedenstellende Haltbarkeit und Gebrauchstauglichkeit auf.
Identifikation	Siehe Anhang A

*) Siehe weitere Informationen unter den Abschnitten 3.9 – 3.12.

**) Zusätzlich zu den spezifischen Klauseln in dieser Europäischen Technischen Bewertung, die sich auf gefährliche Substanzen beziehen, können weitere Anforderungen an die Produkte, die in diesen Bereich fallen, bestehen (z. B. umgesetzte europäische Gesetzgebung und einzelstaatliche Gesetze, Bestimmungen und Verwaltungsvorschriften). Zur Einhaltung der Regelungen der Bauprodukte-Verordnung muss diesen Anforderungen, sofern sie zutreffen, entsprochen werden.

3.9 Mechanische Beständigkeit und Stabilität

Die Tragfähigkeiten der SPAX Schrauben gelten für die in Ziffer 1 genannten Holzwerkstoffe, wenn auch nachstehend nur der Begriff Holz angewendet wird.

Der charakteristische Wert der Abschertragfähigkeit und der charakteristische Wert der axialen Ausziehtragfähigkeit der SPAX Schrauben oder Gewindestangen sollten bei Konstruktionen gemäß Eurocode 5 oder einer entsprechenden nationalen Norm angewendet werden.

Die Einschraubtiefe des spitzenseitigen Gewindeteils muss $\ell_{ef} \geq 4 \cdot d$ betragen, wobei d der Gewindeaußendurchmesser der Schraube oder Gewindestange ist. Zur Befestigung von Aufdach-Dämmsystemen auf Sparren muss die spitzenseitige Einschraubtiefe mindestens 40 mm, $\ell_{ef} \geq 40$ mm, betragen.

Etwaige für Holzbaustoffe oder Holzwerkstoffplatten vorhandene Europäische Technische Bewertungen sind gegebenenfalls zu berücksichtigen.

Durch SPAX Schrauben oder Gewindestangen mit einem Durchmesser von mindestens 10 mm verursachte Reduzierungen der Querschnittsfläche werden bei der Überprüfung der Scherkraft des Bauteils sowohl für die Zug- als auch für die Druckzone berücksichtigt.

Für Schrauben in vorgebohrten Löchern sollte der Bohrlochdurchmesser bei der Überprüfung der Querschnittsschwächung des Bauteils berücksichtigt werden, für Schrauben ohne Vorbohrung der Gewindeinnendurchmesser (= Kerndurchmesser d_2).

Tragfähigkeit rechtwinklig zur Schraubenachse

Der charakteristische Wert der Abschertragfähigkeit von SPAX Schrauben oder Gewindestangen ist nach EN 1995-1-1 (Eurocode 5) mit dem Gewindeaußendurchmesser d als Nenn Durchmesser der Schraube zu berechnen. Die Wirkung des Einhängeeffekts (Seilwirkung) darf dabei berücksichtigt werden.

Der charakteristische Wert des Fließmoments ist wie folgt zu berechnen:

SPAX Schrauben aus Kohlenstoffstahl mit
 $2,5 \text{ mm} \leq d \leq 12,0 \text{ mm}$:

$$M_{y,k} = 0,15 \cdot 600 \cdot d^{2,6} \quad [\text{Nmm}]$$

SPAX Gewindestangen:

$$M_{y,k} = 140000 \quad [\text{Nmm}]$$

SPAX Schrauben aus rostfreiem Stahl mit
 $3,0 \text{ mm} \leq d \leq 12,0 \text{ mm}$:

$$M_{y,k} = 0,15 \cdot 400 \cdot d^{2,6} \quad [\text{Nmm}]$$

Dabei ist

d der Gewindeaußendurchmesser [mm]
 (d_1 in den Zeichnungen im Anhang)

Die Lochleibungsfestigkeit für Schrauben in nicht vorgebohrten Löchern, die in einem Winkel von $0^\circ \leq \alpha \leq 90^\circ$ zwischen Schraubenachse und Faserrichtung angeordnet sind, beträgt:

$$f_{h,k} = \frac{0,082 \cdot \rho_k \cdot d^{-0,3}}{2,5 \cdot \cos^2 \alpha + \sin^2 \alpha} \quad [\text{N/mm}^2]$$

für Schrauben in vorgebohrten Löchern:

$$f_{h,k} = \frac{0,082 \cdot \rho_k \cdot (1-0,01 \cdot d)}{2,5 \cdot \cos^2 \alpha + \sin^2 \alpha} \quad [\text{N/mm}^2]$$

für Gewindestangen in vorgebohrten Löchern:

$$f_{h,k} = \frac{0,082 \cdot \rho_k \cdot (1-0,01 \cdot d)}{(2,5 \cdot \cos^2 \alpha + \sin^2 \alpha) \cdot (k_{90} \cdot \sin^2 \varepsilon + \cos^2 \varepsilon)} \quad [\text{N/mm}^2]$$

Dabei ist

ρ_k die charakteristische Rohdichte des Holzes [kg/m^3];
 d der Gewindeaußendurchmesser [mm];
 α der Winkel zwischen Schraubenachse und Faserrichtung;
 ε der Winkel zwischen Krafrichtung und Faserrichtung;
 k_{90} gemäß Gleichung (8.33) in EN 1995-1-1.

Die Lochleibungsfestigkeit für Schrauben, die parallel zur Plattenebene von Brettsperrholz angeordnet sind, ist, unabhängig vom Winkel zwischen Schraubenachse und Faserrichtung, $0^\circ \leq \alpha \leq 90^\circ$, wie folgt zu berechnen:

$f_{h,k} = 20 \cdot d^{-0,5} \quad [\text{N/mm}^2]$
 sofern in der technischen Spezifikation (ETA oder hEN) für die Brettsperrholzplatte nicht anders angegeben.

Dabei ist

d der Gewindeaußendurchmesser [mm]
 (d_1 in den Zeichnungen im Anhang)

Die Lochleibungsfestigkeit für Schrauben oder Gewindestangen in der Deckfläche von Brettsperrholz ist wie bei Vollholz auf der Grundlage des charakteristischen Werts der Rohdichte der äußeren Schicht zu berechnen. Gegebenenfalls muss der Winkel zwischen Krafrichtung und Faserrichtung der äußeren Schicht berücksichtigt werden.

Die Richtung der Seitenkraft muss quer zur Schraubenachse und parallel zur Deckfläche der Brettsperrholzplatte verlaufen.

Für Schrauben unter Querbelastung sollten die Regeln für Mehrfachverbindungen in EN 1995-1-1, 8.3.1.1 (8) angewandt werden.

Axialer Auszieh Widerstand

Der charakteristische Wert des axialen Auszieh Widerstands von SPAX Schrauben oder Gewindestangen in Bauteilen aus Vollholz (Nadel- und Laubholz mit einer maximalen charakteristischen Rohdichte von 730 kg/m^3), Brettschichtholz und Brettspertholz bei einem Winkel von $15^\circ \leq \alpha \leq 90^\circ$ zur Faserrichtung oder Furnierschichtholz (Nadel- und Laubholz mit einer maximalen charakteristischen Rohdichte von 750 kg/m^3) bei einem Winkel von $30^\circ \leq \alpha \leq 90^\circ$ zur Faserrichtung ist gemäß EN 1995-1-1:2008 nach folgender Gleichung zu berechnen:

$$F_{ax,\alpha,Rk} = \frac{n_{ef} \cdot f_{ax,k} \cdot d \cdot \ell_{ef}}{1,2 \cdot \cos^2 \alpha + \sin^2 \alpha} \cdot \left(\frac{\rho_k}{350} \right)^{0,8} \quad [N]$$

Dabei ist

$F_{ax,\alpha,Rk}$	Charakteristischer Wert des Auszieh Widerstands der Schraube unter einem Winkel α zur Faserrichtung [N]
n_{ef}	Effektiv wirksame Anzahl der Schrauben gemäß EN 1995-1-1:2008
$f_{ax,k}$	Charakteristischer Ausziehparameter $2,5 \text{ mm} \leq d < 6,0 \text{ mm}$: $f_{ax,k} = 14,0 \text{ N/mm}^2$ $6,0 \text{ mm} \leq d \leq 8,0 \text{ mm}$: $f_{ax,k} = 12,0 \text{ N/mm}^2$ $d = 10,0 \text{ mm}$: $f_{ax,k} = 11,5 \text{ N/mm}^2$ $d = 12,0 \text{ mm}$: $f_{ax,k} = 11,0 \text{ N/mm}^2$ $d = 16,0 \text{ mm}$: $f_{ax,k} = 10,0 \text{ N/mm}^2$
d	Gewindeaußendurchmesser [mm] (d_1 in den Zeichnungen im Anhang)
ℓ_{ef}	Einschraubtiefe des Gewindeteils gemäß EN 1995-1-1 [mm]; für das Gewinde unter dem Kopf einschließlich Kopfhöhe
α	Winkel zwischen Faserrichtung und Schraubenachse
ρ_k	charakteristische Rohdichte [kg/m^3]

Bei Schrauben, die in mehr als eine Schicht von Brettspertholz eindringen, können die verschiedenen Schichten proportional berücksichtigt werden.

Der axiale Auszieh Widerstand wird durch den Kopfdurchzieh Widerstand und die Zug- oder Drucktragfähigkeit der Schraube oder Gewindestange begrenzt.

Für SPAX Schrauben oder Gewindestangen kann der Auszieh Widerstand des Gewindes im kopfseitigen Bauteil anstelle des Durchzieh Widerstands berücksichtigt werden.

Für Schrauben unter Zugbeanspruchung, bei denen die externe Kraft parallel zur Schraubenachse verläuft, sollten die Regeln in EN 1995-1-1, 8.7.2 (8) gelten.

Für geneigte Schrauben in Holz-Holz- oder Stahl-Holz-Scherverbindungen, bei denen die Schrauben in einem Winkel von $30^\circ \leq \alpha \leq 60^\circ$ zwischen Scherfläche und Schraubenachse angeordnet sind, sollte die effektiv wirksame Anzahl der Schrauben n_{ef} folgendermaßen berechnet werden:

Für eine Reihe mit n Schrauben parallel zur Last sollte die Tragfähigkeit anhand der effektiv wirksamen Anzahl der Befestigungen n_{ef} berechnet werden. Dabei ist

$$n_{ef} = \max \{ n^{0,9}; 0,9 \cdot n \}$$

n die Anzahl der geneigten Schrauben in einer Reihe. Wenn gekreuzte Schraubenpaare in Holz-Holz-Verbindungen verwendet werden, ist n die Anzahl der gekreuzten Schraubenpaare in einer Reihe.

Hinweis: Für Schrauben als Querdruckverstärkung oder geneigte Schrauben als Befestigungen in nachgiebig verbundenen Balken oder Säulen oder für die Befestigung von Wärmedämmmaterialien ist $n_{ef} = n$.

Kopfdurchzieh Widerstand

Der charakteristische Kopfdurchzieh Widerstand von SPAX Schrauben oder Gewindestangen ist gemäß EN 1995-1-1:2008 nach folgender Gleichung zu ermitteln:

$$F_{ax,\alpha,Rk} = \max \left\{ \frac{f_{ax,k} \cdot d \cdot \ell_{ef}}{1,2 \cdot \cos^2 \alpha + \sin^2 \alpha}; k_t \cdot f_{head,k} \cdot d_h^2 \right\} \cdot n_{ef} \cdot \left(\frac{\rho_k}{350} \right)^{0,8} \quad [N]$$

Dabei ist

$F_{ax,\alpha,Rk}$	Charakteristischer Kopfdurchzieh Widerstand der Verbindung bei einem Winkel $\alpha \geq 30^\circ$ zur Faserrichtung [N]
n_{ef}	Effektiv wirksame Anzahl der Schrauben gemäß EN 1995-1-1:2008 Für geneigte Schrauben: $n_{ef} = \max \{ n^{0,9}; 0,9 \cdot n \}$ (siehe axialer Auszieh Widerstand)
k_t	Faktor zur Berücksichtigung der kopfseitigen Bauteildicke t_h $k_t = 1$ für $t_h/d_h < 3$ $k_t = 1,3$ für $t_h/d_h \geq 3$
$f_{head,k}$	Charakteristischer Kopfdurchziehparameter [N/mm^2]
d_h	Durchmesser des Schraubenkopfes oder der Unterlegscheibe [mm]. Außendurchmesser der Schraubenköpfe oder Unterlegscheiben von $d_h > 32 \text{ mm}$ dürfen nur mit einem Nenn Durchmesser von 32 mm berücksichtigt werden.
ρ_k	charakteristische Rohdichte [kg/m^3], für Holzwerkstoffplatten $\rho_k = 380 \text{ kg/m}^3$

Charakteristischer Kopfdurchziehparameter für SPAX Schrauben mit Senk- oder Sechskantkopf ohne Bund in Verbindungen mit Holz und Holzwerkstoffen mit einer Dicke von über 20 mm :

$$d_h \leq 16 \text{ mm}: f_{head,k} = 27,0 - d_h \text{ [N/mm}^2\text{]} \\ 16 \text{ mm} < d_h \leq 32 \text{ mm}: f_{head,k} = 11,0 - 0,2 \cdot (d_h - 16) \text{ [N/mm}^2\text{]}$$

Charakteristischer Durchziehparameter für SPAX Schrauben mit Tellerkopf, Flachkopf, Sechskantkopf mit Bund, Senkkopf mit Unterlegscheibe oder mit zweitem Gewinde unter dem Kopf in Verbindungen mit Holz und Holzwerkstoffen mit einer Dicke von über 20 mm:

$$d_h \leq 16 \text{ mm: } f_{\text{head,k}} = 29,0 - d_h \text{ [N/mm}^2\text{]}$$

$$16 \text{ mm} < d_h \leq 22 \text{ mm: } f_{\text{head,k}} = 13,0 \text{ [N/mm}^2\text{]}$$

$$22 \text{ mm} < d_h \leq 32 \text{ mm: } f_{\text{head,k}} = 16,0 - 0,5 \cdot (d_h - 16) \text{ [N/mm}^2\text{]}$$

Dabei ist

d_h der Durchmesser des Schraubenkopfes oder der Unterlegscheibe [mm]

Charakteristischer Durchziehparameter für Schrauben in Verbindungen mit Holzwerkstoffen mit einer Dicke zwischen 12 mm und 20 mm:

$$f_{\text{head,k}} = 8 \text{ N/mm}^2$$

Schrauben in Verbindungen mit Holzwerkstoffen mit einer Dicke von unter 12 mm (Mindestdicke für Holzwerkstoffe beträgt $1,2 \cdot d$, wobei d den Gewindeaußendurchmesser beschreibt):

$$f_{\text{head,k}} = 8 \text{ N/mm}^2$$

$$\text{begrenzt auf } F_{\text{ax,Rk}} = 400 \text{ N}$$

Für Schrauben mit Teilgewinde mit glatter Schraubenschaft unter dem Kopf muss der Durchmesser des Kopfes oder der Unterlegscheibe mindestens $1,8 \cdot d_s$ betragen, wobei d_s dem glatten Schraubenschaft oder dem Drahtdurchmesser entspricht. Andernfalls beträgt der charakteristische Durchziehparameter $F_{\text{ax,Rk}} = 0$ für Schrauben mit glatter Schaft unter dem Kopf.

Die Mindestdicke des Holzwerkstoffes nach Ziffer 2.1 ist einzuhalten.

In Stahl-Holz-Verbindungen ist der Kopfdurchziehparameter nicht maßgeblich.

Zugtragfähigkeit

Der charakteristische Wert der Zugtragfähigkeit $f_{\text{tens,k}}$ von SPAX Schrauben aus Kohlenstoffstahl oder Gewindestangen aus Kohlenstoffstahl oder rostfreiem Stahl beträgt:

$d = 2,5 \text{ mm:}$	1,8 kN
$d = 3,0 \text{ mm:}$	2,6 kN
$d = 3,5 \text{ mm:}$	3,8 kN
$d = 4,0 \text{ mm:}$	5,0 kN
$d = 4,5 \text{ mm oder } 4,6 \text{ mm:}$	6,4 kN
$d = 5,0 \text{ mm:}$	7,9 kN
$d = 5,6 \text{ mm:}$	9,9 kN
$d = 6,0 \text{ mm:}$	11 kN
$d = 7,0 \text{ mm:}$	13 kN
$d = 8,0 \text{ mm:}$	17 kN
$d = 10,0 \text{ mm:}$	28 kN
$d = 12,0 \text{ mm:}$	38 kN

Gewindestangen $d = 16 \text{ mm:}$ 63 kN

Der charakteristische Wert der Zugfestigkeit $f_{\text{tens,k}}$ von SPAX Schrauben aus rostfreiem Stahl beträgt:

$d = 3,0 \text{ mm:}$	2,1 kN
$d = 3,5 \text{ mm:}$	2,9 kN
$d = 4,0 \text{ mm:}$	3,8 kN
$d = 4,5 \text{ mm oder } 4,6 \text{ mm:}$	4,2 kN
$d = 5,0 \text{ mm oder } 5,2 \text{ mm:}$	4,9 kN
$d = 5,6 \text{ mm:}$	6,2 kN
$d = 6,0 \text{ mm:}$	7,1 kN
$d = 7,0 \text{ mm:}$	10 kN
$d = 8,0 \text{ mm:}$	13 kN
$d = 10,0 \text{ mm:}$	20 kN
$d = 12,0 \text{ mm:}$	28 kN

Die Abreißfestigkeit des Schraubenkopfes ist größer als die Zugfestigkeit der Schraube.

Drucktragfähigkeit

Der Bemessungswert der Drucktragfähigkeit $F_{\text{ax,Rd}}$ von SPAX Schrauben oder Gewindestangen mit Vollgewinde in Holz ist wie folgt zu berechnen:

$$F_{\text{ax,Rd}} = \min \left\{ \frac{f_{\text{ax,d}} \cdot d \cdot \ell_{\text{ef}}}{1,2 \cdot \cos^2 \alpha + \sin^2 \alpha} \cdot \left(\frac{\rho_k}{350} \right)^{0,8}; \frac{\kappa_c \cdot N_{\text{pl,k}}}{\gamma_{\text{M1}}} \right\} \text{ [N]}$$

Dabei ist

$$\kappa_c = \begin{cases} 1 & \text{für } \bar{\lambda}_k \leq 0,2 \\ \frac{1}{k + \sqrt{k^2 - \bar{\lambda}_k^2}} & \text{für } \bar{\lambda}_k > 0,2 \end{cases}$$

$$k = 0,5 \cdot [1 + 0,49 \cdot (\bar{\lambda}_k - 0,2) + \bar{\lambda}_k^2]$$

Der relative Schlankheitsgrad ist wie folgt zu berechnen:

$$\bar{\lambda}_k = \sqrt{\frac{N_{\text{pl,k}}}{N_{\text{ki,k}}}}$$

Dabei ist

$$N_{\text{pl,k}} = \pi \cdot \frac{d_1^2}{4} \cdot f_{\text{y,k}} \text{ [N]}$$

der charakteristische Wert der plastischen Normalkrafttragfähigkeit des Nettoquerschnitts

Charakteristische Streckgrenze:

$$f_{\text{y,k}} = 1000 \text{ [N/mm}^2\text{]}$$

für SPAX Schrauben aus Kohlenstoffstahl

$f_{y,k} = 500$ [N/mm²]
für SPAX Gewindestangen und SPAX Schrauben aus
rostfreiem Stahl

Dabei ist
 d der Gewindeaußendurchmesser [mm]
 ℓ_{ef} die Eindringtiefe in das Bauteil [mm]

Charakteristischer Wert der idealen elastischen Knicklast:

$$N_{ki,k} = \sqrt{c_h \cdot E_s \cdot I_s} \quad [N]$$

Elastisches Fundament der Schraube:

$$c_h = (0,19 + 0,012 \cdot d) \cdot \rho_k \cdot \left(\frac{\alpha}{180^\circ} + 0,5 \right) \quad [N/mm^2]$$

Für Schrauben in Brettsperrholz ist die ungünstigste Kombination von α und ρ_k maßgeblich;

Elastizitätsmodul:

$$E_s = 210000 \quad [N/mm^2]$$

ρ_k = charakteristische Rohdichte [kg/m³]

Zweites Flächenmoment:

$$I_s = \frac{\pi}{64} \cdot d_1^4 \quad [mm^4]$$

d_1 = Kerndurchmesser [mm]
(d_2 in den Zeichnungen im Anhang)

α = Winkel zwischen Schraubenachse und Faserrichtung

Hinweis: Bei der Bestimmung der Bemessungswerte der Drucktragfähigkeit muss berücksichtigt werden, dass $f_{ax,d}$ unter Verwendung von k_{mod} und γ_M für Holz gemäß EN 1995 zu berechnen ist, während $N_{pl,d}$ unter Verwendung von $\gamma_{M,1}$ für Stahl gemäß EN 1993 berechnet wird.

Schrauben und Gewindestangen mit kombinierter Quer- und Zugbeanspruchung

Bei Verschraubungen, die einer kombinierten Axial- und Querbeanspruchung ausgesetzt sind, muss die folgende Bedingung erfüllt sein:

$$\left(\frac{F_{ax,Ed}}{F_{ax,Rd}} \right)^2 + \left(\frac{F_{la,Ed}}{F_{la,Rd}} \right)^2 \leq 1$$

Dabei ist

$F_{ax,Ed}$ der Bemessungswert der Kraft in Achsrichtung der Schraube oder Gewindestange

$F_{la,Ed}$ der Bemessungswert der Kraft rechtwinklig zur Schraubachse

$F_{ax,Rd}$ der Bemessungswert der Zugtragfähigkeit der Schraube oder Gewindestange

$F_{la,Rd}$ der Bemessungswert der Abscherfähigkeit der Schraube oder Gewindestange

Verschiebungsmodul

Das axiale Verschiebungsmodul K_{ser} einer Schraube für den Grenzzustand der Gebrauchstauglichkeit beträgt unabhängig vom Winkel α zur Faser:

$$C = K_{ser} = 25 \cdot d \cdot \ell_{ef} \quad [N/mm]$$

Verstärkung von querdruckbeanspruchten Holzbauteilen
Siehe Anhang C.

Verstärkung von querzugbeanspruchten Holzbauteilen
Siehe Anhang D.

Schubverstärkung
Siehe Anhang E.

Befestigung von Aufdach-Dämmsystemen
Siehe Anhang F.

3.10 Weitere Aspekte der Gebrauchstauglichkeit

3.10.1 Korrosionsschutz in Nutzungsklasse 1, 2 und 3.

SPAX Schrauben und Gewindestangen werden aus Kohlenstoffstahldraht hergestellt. Sie sind vermessingt, vernickelt, brüniert oder verzinkt und z. B. gelb oder blau passiviert, mit einer Zinkschichtdicke von 4 – 16 μ m oder Zinklamellenbeschichtung mit Schichtdicken von 10 - 20 μ m.

Schrauben aus Edelstahl bestehen aus Stahl der Werkstoffnummern 1.4016, 1.4062, 1.4401, 1.4567, 1.4578, 1.4529 oder 1.4539.

3.11 Allgemeine Aspekte hinsichtlich der beabsichtigten Nutzung des Produkts

Die Schrauben bzw. Gewindestangen werden gemäß den Bestimmungen der Europäischen Technischen Bewertung unter Anwendung des automatisierten Herstellungsverfahrens hergestellt, das die die ETA ausstellende Bewertungsstelle und die benannte Prüfstelle bei der Inspektion der Fertigungsanlage ermittelt und in der technischen Dokumentation festgehalten haben.

Der Einbau hat gemäß Eurocode 5 oder einer entsprechenden nationalen Norm zu erfolgen, es sei denn, nachstehend wurden andere Festlegungen getroffen. Die Einbauanleitungen der SPAX International GmbH & Co. KG müssen berücksichtigt werden.

Die Schrauben bzw. Gewindestangen sind für die Verwendung in tragenden Holzkonstruktionen zur Verbindung von Teilen aus Vollholz (Nadelholz), Brettchichtholz (Nadelholz), Brettsperrholz (Minstdurchmesser $d = 6,0$ mm) und Furnierschichtholz, ähnlich verleimten Holzbauteilen, Holzwerkstoffplatten oder von Stahlteilen bestimmt. Die Schrauben sind außerdem für die Verwendung in tragenden Teilen aus Vollholz (Laubholz) oder Brettchichtholz (Laubholz) bestimmt.

Die Schrauben bzw. Gewindestangen können in tragenden Holzkonstruktionen zur Verbindung von Bauteilen gemäß einer etwaigen Europäischen Technischen Bewertung des Bauteils verwendet werden, sofern gemäß der Europäischen Technischen Bewertung des betreffenden Bauteils der Anbau an tragende Holzkonstruktionen mit Schrauben zulässig ist.

SPAX Schrauben mit Vollgewinde bzw. Gewindestangen auch als Zug- oder Druckbewehrung quer zur Faser oder als Schubbewehrung in Holzbauteile aus Nadelholz verwendet werden.

Zudem können die Schrauben mit Durchmessern zwischen 6 mm und 12 mm können auch zur Befestigung von Wärmedämmmaterialien auf Sparren verwendet werden.

Bei Verbindungen in tragenden Holzkonstruktionen müssen jeweils mindestens zwei Schrauben bzw. Gewindestangen verwendet werden. Dies gilt nicht für Bewehrungen oder andere in den nationalen Anhängen von EN 1995-1-1 genannte Situationen.

Die Mindesteinschraubtiefe in Bauteile aus Vollholz, Brett-schichtholz oder Brettspertholz beträgt 4·d.

Holzwerkstoffplatten und Stahlplatten sollten nur auf der Seite des Schraubenkopfes angebracht werden. Holzwerkstoffplatten sollten eine Dicke von mindestens 1,2·d aufweisen. Zudem sollten bei folgenden Holzwerkstoffen die jeweiligen Mindestdicken beachtet werden:

- Sperrholz, Faserplatten: 6 mm
- Spanplatten, OSB-Platten, zementgebundene Spanplatten: 8 mm
- Vollholzplatten: 12 mm

Für Bauteile nach Europäischer Technischer Bewertung sind die Bedingungen der jeweils einschlägigen Europäischen Technischen Bewertung zu berücksichtigen.

Werden Schrauben mit einem Gewindeaußendurchmesser von $d \geq 8$ mm in tragenden Holzkonstruktionen verwendet, so müssen das Vollholz, Brett-schichtholz, Furnierschicht-holz LVL und ähnlich verleimte Werkstoffe aus Fichten-, Kiefern- oder Tannenholz bestehen. Dies gilt nicht für das Einschrauben in vorgebohrte Löcher.

Die Schrauben dürfen in Weichholz mit oder ohne Vorbohren eingedreht werden. Die Schrauben können in Laubholz mit einer maximalen charakteristischen Rohdichte von 750 kg/m^3 eingedreht werden, die Gewindestangen mit Vorbohren in Nadelholz. Die Bohrlochdurchmesser betragen:

Gewindeaußendurchmesser	Bohrlochdurchmesser	
	Nadelholz	Laubholz
4,0	2,5	3,0
4,5	3,0	3,0
4,6	3,0	3,0
5,0	3,0	3,5
5,2	3,0	3,5
5,6	3,0	4,0
6,0	4,0	4,0
7,0	4,0	5,0
8,0	5,0	6,0
10,0	6,0	7,0
12,0	7,0	8,0
16,0	13,0	-

In Stahlteilen sind die Löcher mit einem geeigneten Durchmesser vorzubohren.

Für das Einschrauben der Schrauben sind ausschließlich die von der SPAX GmbH & Co. KG benannten Einschraubgeräte zu verwenden.

In Verbindungen mit Senkkopfschrauben gemäß Anhang A muss der Schraubenkopf bündig mit der Oberfläche des Anbauteils abschließen. Ein tieferes Versenken ist nicht zulässig.

Wenn nicht anders definiert, beträgt die Mindestdicke für Bauteile ohne Vorbohrung $t = 24$ mm bei Schrauben mit einem Gewindeaußendurchmesser von $d < 8$ mm, $t = 30$ mm bei Schrauben mit einem Gewindeaußendurchmesser von $d = 8$ mm, $t = 40$ mm bei Schrauben mit einem Gewindeaußendurchmesser von $d = 10$ mm und $t = 80$ mm bei Schrauben mit einem Gewindeaußendurchmesser von $d = 12$ mm.

Der Abstand zum beanspruchten und unbeanspruchten Rand muss bei Schrauben in nicht vorgebohrten Löchern mit einem Gewindeaußendurchmesser von $d \geq 8$ mm und einer Holzdicke von $t < 5 \cdot d$ mindestens $15 \cdot d$ betragen.

Der Mindestabstand vom unbeanspruchten Rand quer zur Faserrichtung kann auch bei einer Holzdicke von $t < 5 \cdot d$ auf $3 \cdot d$ reduziert werden, sofern der Abstand in Faserrichtung und zum Hirnholzende mindestens $25 \cdot d$ beträgt.

Bei Bauteilen aus Douglasie sind die Mindestabstände in Faserrichtung um 50 % zu erhöhen.

Für Holzbauteile gibt EN 1995-1-1:2008 (Eurocode 5) in Abschnitt 8.3.1.2 und Tabelle 8.2 jeweils Mindestabstände für Schrauben in vorgebohrten Löchern sowie für Nägel in vorgebohrten Nagellöchern an. Diese Mindestabstände gelten auch für SPAX Schrauben mit CUT-Spitze oder 4CUT in der Spitze in nicht vorgebohrten Löchern. Dabei ist der Gewindeaußendurchmesser d zu berücksichtigen. Bei SPAX Schrauben mit CUT-Spitze oder 4CUT in der Spitze in nicht vorgebohrten Löchern müssen die folgenden Bedingungen erfüllt sein:

- $a_1 \geq 5 \cdot d$
- $a_{3,c} \geq 12 \cdot d$
- $a_{3,t} \geq 12 \cdot d$
- Mindestquerschnitt $\geq 40 d^2$
- Schrauben mit CUT-Spitze:

$t_{\min} = \max \{5 \cdot d ; 20 \text{ mm}\}$	für $d \leq 6$ mm
$t_{\min} = 7 \cdot d$	für $d \geq 8$ mm
- Schrauben mit 4CUT in der Spitze:

$t_{\min} = \max \{6 \cdot d ; 20 \text{ mm}\}$	für $d \leq 6$ mm
$t_{\min} = 7 \cdot d$	für $d \geq 8$ mm

Für SPAX Schrauben, die die oben genannten Bedingungen nicht erfüllen, oder für Schrauben in Furnierschichtholz sind die Mindestabstände, genau wie für Nägel in nicht vorgebohrten Nagellöchern, in EN 1995-1-1:2008 in Abschnitt 8.3.1.2 und in Tabelle 8.2 angegeben.

Alternativ gelten folgende Mindestabstände für ausschließlich axial belastete SPAX Schrauben mit CUT-Spitze oder 4CUT in der Spitze oder mit $d \leq 8$ mm in nicht vorgebohrten Löchern in Bauteilen aus Vollholz, Brettschichtholz oder ähnlich verleimten Produkten mit einer Mindestdicke von $t = 12 \cdot d$:

Abstand a_1 parallel zur Faserrichtung	$a_1 = 5 \cdot d$
Abstand a_2 quer zur Faserrichtung	$a_2 = 5 \cdot d$
Abstand $a_{3,c}$ von Mitte des Schraubenteils in Holz bis zum Hirnholz	$a_{3,c} = 5 \cdot d$
Abstand $a_{4,c}$ von Mitte des Schraubenteils in Holz bis zum Rand	$a_{4,c} = 4 \cdot d$
Abstand $a_{4,c}$ von Mitte des Schraubenteils in Holz bis zum Rand nur für Schrauben mit CUT-Spitze oder 4CUT in der Spitze	$a_{4,c} = 3 \cdot d$

Der Abstand a_2 quer zur Faser kann von $5 \cdot d$ auf $2,5 \cdot d$ reduziert werden, wenn die Bedingung $a_1 \cdot a_2 \geq 25 \cdot d^2$ erfüllt ist.

Alternativ gelten folgende Mindestabstände für ausschließlich unter Zugbelastung stehende SPAX Schrauben in Bauteilen aus Furnierschichtholz LVL (Nadelholz) mit einer Mindestdicke von $t = 6 \cdot d$:

Abstand a_1 parallel zur Faserrichtung	$a_1 = 5 \cdot d$
Abstand a_2 quer zur Faserrichtung	$a_2 = 5 \cdot d$
Abstand $a_{3,c}$ von Mitte des Schraubenteils in Holz bis zum Hirnholz	$a_{3,c} = 5 \cdot d$
Abstand $a_{4,c}$ von Mitte des Schraubenteils in Holz bis zum Rand	$a_{4,c} = 3 \cdot d$

Der Abstand a_2 quer zur Faser kann von $5 \cdot d$ auf $2,5 \cdot d$ reduziert werden, wenn die Bedingung $a_1 \cdot a_2 \geq 25 \cdot d^2$ erfüllt ist.

Sofern in der technischen Spezifikation (ETA oder hEN) von Brettsperrholz nicht anders definiert, gelten folgende Mindestabstände für Schrauben in der Deckfläche von Bauteilen aus Brettsperrholz mit einer Mindestdicke von $t_{CLT} = 10 \cdot d$ (siehe Anhang B):

Abstand a_1 parallel zur Faserrichtung	$a_1 = 4 \cdot d$
Abstand a_2 quer zur Faserrichtung	$a_2 = 2,5 \cdot d$
Abstand $a_{3,c}$ von Mitte des Schraubenteils in Holz bis zum unbeanspruchten Hirnholzende	$a_{3,c} = 6 \cdot d$
Abstand $a_{3,t}$ von Mitte des Schraubenteils in Holz bis zum beanspruchten Hirnholzende	$a_{3,t} = 6 \cdot d$
Abstand $a_{4,c}$ von Mitte des Schraubenteils in Holz bis zum unbeanspruchten Rand	$a_{4,c} = 2,5 \cdot d$
Abstand $a_{4,t}$ von Mitte des Schraubenteils in Holz bis zum beanspruchten Rand	$a_{4,t} = 6 \cdot d$

Sofern in der technischen Spezifikation (ETA oder hEN) von Brettsperrholz nicht anders definiert gelten folgende Mindestabstände für Schrauben in der Schmalfläche von Bauteilen aus Brettsperrholz mit einer Mindestdicke von $t_{CLT} = 10 \cdot d$ und einer Mindesteindringtiefe quer zur Schmalfläche von $10 \cdot d$ (siehe Anhang B):

Abstand a_1 parallel zur CLT-Deckfläche	$a_1 = 10 \cdot d$
Abstand a_2 quer zur CLT-Deckfläche	$a_2 = 4 \cdot d$
Abstand $a_{3,c}$ von Mitte des Schraubenteils in Holz bis zum unbeanspruchten Rand	$a_{3,c} = 7 \cdot d$
Abstand $a_{3,t}$ von Mitte des Schraubenteils in Holz bis zum beanspruchten Rand	$a_{3,t} = 12 \cdot d$
Abstand $a_{4,c}$ von Mitte des Schraubenteils in Holz bis zum unbeanspruchten Rand	$a_{4,c} = 3 \cdot d$
Abstand $a_{4,t}$ von Mitte des Schraubenteils in Holz bis zum beanspruchten Rand	$a_{4,t} = 6 \cdot d$

Für SPAX Schrauben oder Gewindestangen in vorgebohrten Löchern gelten die oben genannten Anforderungen an die Mindestdicke nicht.

Für zwei sich kreuzende Schrauben ist der Mindestabstand zwischen den sich überschneidenden Schrauben in Anhang B angegeben.

Die Mindestabstände für SPAX Schrauben in nachgiebig verbundenen Balken sind in Anhang B aufgeführt.

4 Beurteilung und Prüfung der Leistungsbeständigkeit (AVCP)

4.1 AVCP-System

Gemäß der Entscheidung 97/176/EG der Europäischen Kommission¹ in der geänderten Fassung ist das System der Bewertung und Überprüfung der Leistungsbeständigkeit (siehe Anhang V der Verordnung (EU) Nr. 305/2011) 3.

5 Technische Details, die notwendig für die Umsetzung des AVCP-Systems sind, wie in der geltenden EAD vorgesehen

Technische Details, die für die Umsetzung des AVCP-Systems erforderlich sind, sind im Kontrollplan vermerkt, der vor der CE-Zertifizierung bei ETA-Danmark hinterlegt wurde.

Ausgestellt in Kopenhagen von

Thomas Bruun
Geschäftsführer, ETA-Danmark

S1.1 Übersetzung technischer Begrifflichkeiten für Anhang A

Zeichnungen, Bezeichnung und Materialspezifikation von SPAX Schrauben

english	deutsch
1 (Seitenkopf)	
Self-drilling screw with full and partial thread	Selbstbohrende Schraube mit Voll- oder Teilgewinde
Self-drilling screw with double thread	Selbstbohrende Schraube mit Doppelgewinde
Self-drilling screw with full thread	Selbstbohrende Schraube mit Vollgewinde
Full- thread, self-drilling screw	Selbstbohrende Schraube mit Vollgewinde
Washer for screws with countersunk and raised countersunk head	Unterlegscheibe für Schrauben mit Senkkopf und Linsensenkkopf
Threaded rod with full thread	Gewindestange mit Vollgewinde
Self-tapping screw with CUT-point	Selbstbohrende Schraube mit CUT-Spitze
Self-tapping cylindric head screw with fixing thread	Selbstbohrende Zylinderkopfschraube mit Befestigungsgewinde
Self-tapping flat countersunk head screw with CUT-point	Selbstbohrende Flachsenkopfschraube mit CUT-Spitze
Self-tapping flat countersunk head screw with fixing thread	Selbstbohrende Flachsenkopfschraube mit Befestigungsgewinde
Self-tapping raised countersunk head screw with fixing thread	Selbstbohrende Linsensenkschraube mit Befestigungsgewinde
Self-tapping cylindric head screw with fixing thread	Selbstbohrende Zylinderkopfschraube mit Befestigungsgewinde
Self-tapping raised countersunk head screw with CUT-point	Selbstbohrende Linsensenkschraube mit CUT-Spitze
Flat countersunk head	Senkkopf
Washer head	Tellerkopf
Raised countersunk head	Linsensenkkopf
Pan head	Halbrundkopf
Countersunk head with cutting ribs	Senkkopf mit Fräsrippen
Countersunk with head hole	Senkkopf mit Kopflochbohrung
Hex. head with/without flange	Sechskantkopf mit/ohne Bund
Washer	Unterlegscheibe
Material: cold rolled wire according to SPAX - Factory Standard	Material: Kaltstachdraht gemäß SPAX Werksnorm
Screws of high carbon steel	Schrauben aus Kohlenstoffstahl
Stainless steel screws	Schrauben aus Edelstahl rostfrei
Material: machining steel Dimensions in mm	Material: Automatenstahl Maße in mm
Material: Steel or Stainless steel	Material: Stahl oder Edelstahl rostfrei
Stainless steel	Edelstahl rostfrei
Steel	Stahl

S1.1 Übersetzung technischer Begrifflichkeiten für Anhang A

Zeichnungen, Bezeichnung und Materialspezifikation von SPAX Schrauben

english	deutsch
2 (Grafikbereich)	
Manufacturer's trade mark \triangle	Herstellerzeichen \triangle
Manufacturer's trade mark "SPAX"	Herstellerzeichen "SPAX"
Manufacturer's trade mark \triangle or "SPAX"	Herstellerzeichen \triangle oder "SPAX"
Manufacturer's trade mark T-STAR plus T10	Herstellerzeichen T-STAR plus T10
Cross recess Type Z	Kreuzschlitz Typ Z
Design with hexagon head	Ausführung mit Sechskantkopf
Design without head	Ausführung ohne Kopf
Cross section A - B	Querschnitt A-B
4CUT-point: Square point in core	4CUT in der Spitze: Vierkantspitze
Optional with and without ribs	Wahlweise mit und ohne Rippen
Optional with or without ribs or Multihead	Wahlweise mit oder ohne Rippen oder MULTI-Kopf
Cutting ribs	Fräsrippen
Head-end thread corresponds of the point thread geometry	Kopfseitiges Gewinde entspricht der Spitzengewindegeometrie
A: alternatively with CUT-point	A: alternativ mit CUT-Spitze
C: alternatively with 4CUT-cutter*	C: alternativ Schaftfräser mit 4CUT *
D: 4CUT-point	D: 4CUT in der Spitze
alternativ head geometry	alternative Kopfgeometrie
Screw adapter available as accessory	Einschraubhülse als Zubehör erhältlich
Screw with CUT-point	Schraube mit CUT-Spitze
Square Point in core	Vierkantspitze

S1.1 Übersetzung technischer Begrifflichkeiten für Anhang A (Fortsetzung)

english	deutsch
3 (Abmessungen)	
Nominal diameter	Nenndurchmesser
Type of Head	Kopftyp
d1 - thread size	d1 - Gewindegröße
permissible tolerance	zulässige Abweichung
Tolerance	Toleranz
SW - wrench size/width across flat	Schlüsselweite
Dc - flange diameter	Bunddurchmesser
dk - head diameter	Kopfdurchmesser
dk1 - countersink diameter	Senkdurchmesser
db - hole diameter	Lochdurchmesser
d2 - core diameter	Kerndurchmesser
ds, ds1, ds2 - shank diameter	Schaftdurchmesser
k - head height max.	Kopfhöhe max.
p - thread pitch	Gewindesteigung
4 (Abmessungen)	
Nom.dim.	Nennmaß
Standard thread lengths (full thread = lgV / partial thread = lgT)	Standardgewindelängen (Vollgewinde = lgV / Teilgewinde = lgT)
Thread-free length X	Gewindefreie Länge X
permissible tolerance of screw length	Zulässige Abweichung für Schraubenlänge
to	bis
5 (Fußbereich)	
Screws of Ø 6,0 mm with partial thread additionally in length of 180 to 300 mm, in steps of 20 mm, LgT= 68,0 mm	Schrauben mit Ø 6,0 mm und Teilgewinde zusätzlich in Längen von 180 bis 300 mm; in Schritten von jeweils 20 mm, LgT = 68,0 mm
Lengths over 200 mm to 400 mm in steps of 20 mm	Längen von 200 mm bis 400 mm in Schritten von jeweils 20 mm
Other thread lengths in the range $\geq 4 \times d1$ to max. standard length permitted.	Andere Gewindelängen im Bereich $\geq 4 \cdot d1$ bis max. Standardlänge zulässig.
Intermediate lengths on Ls possible	Zwischenlängen bei Ls möglich
Screw lengths Ls up to 600 mm (Lengths > 400 mm with cut point)	Schraubenlängen Ls bis 600 mm (Längen > 400 mm mit CUT-Spitze)
Screw lengths Ls to 600 mm possible	Schraubenlängen Ls bis 600 mm möglich
Screw lengths Ls up to 600 mm possible (at a nominal diameter of 8,0 mm lengths > 400 mm with CUT-point)	Schraubenlängen Ls bis 600 mm möglich (bei Nenndurchmesser von 8,0 mm: Längen > 400 mm mit CUT-Spitze)
* Design C with lgT= max. 65,0 mm	* Ausführung C mit lgT = max 65,0 mm
= Preferred size	= Bevorzugte Größe
Other lengths 100 - 3000 mm possible	Andere Längen von 100 bis 3000 mm möglich
Other thread lengths (lgT) are acceptable if $lgT > 4 \times 3,5$	andere Gewindelängen (lgT) sind zulässig, wenn $lgT > 4 \times 3,5$
Length can be changed by cutting the threaded part	Die Länge kann durch Kürzen des Gewindes verändert werden
Annex A54	Anhang A54

 SPAX®-S Flat countersunk head		Self-tapping screw with full and partial thread															
		Material: cold rolled wire according to SPAX - Factory Standard Screws of high carbon steel															
Nominal diameter		2,5	3,0	3,5	4,0	4,5	5,0	6,0									
d1	thread size	2,5	3,1	3,5	4,0	4,5	5,0	6,0									
	permissible tolerance				±0,3												
dk	head diameter	5,1	6,0	7,0	8,0	8,8	9,7	11,6									
	permissible tolerance	±0,5					±0,6										
d2	core diameter	1,7	1,9	2,2	2,5	2,8	3,2	3,8									
	permissible tolerance	-0,30	+0,15/-0,25	-0,30	±0,3												
ds	shank diameter	1,8	2,15	2,45	2,85	3,20	3,55	4,30									
	permissible tolerance	±0,10															
k	head height max.	1,6	1,8	2,1	2,4	2,7	2,9	3,4									
p	thread pitch	1,3	1,5	1,8	2,0	2,2	2,5	3,0									
	permissible tolerance	±0,1 x p															
T-STAR size		T8	T10	T15 / T20	T20		T25	T30									
Cross recess size Type Z		1		2				3									
Ls		Standard thread lengths (full thread = lgV / partial thread = lgT)															
Nom. dim.	min	max	lgV	lgT	lgV	lgT	lgV	lgT	lgV	lgT	lgV	lgT	lgV	lgT	lgV	lgT	
12	12,0	13,5	10,0														
15	14,0	15,5	12,0		12,5												
16	16,0	17,5	14,0		14,0												
20	18,5	20,5	17,0	12,0	17,0		16,0		16,0								
25	23,5	25,5	22,0	18,0	22,0	18,0	21,0	18,0	21,0	20,0		20,0					
30	28,5	30,5	27,0	18,0	26,0	18,0	25,0	18,0	25,0	18,0	25,0		25,0		24,0		
35	33,5	36,0		22,0	31,0	23,0	30,0	23,0	30,0	23,0	30,0	25,0	30,0	25,0	29,0	24,0	
40	38,5	41,0		22,0	36,0	23,0	35,0	23,0	35,0	23,0	34,0	25,0	35,0	27,0	34,0	24,0	
45	43,5	46,0		28,0	36,0	28,0	40,0	30,0	40,0	30,0	39,0	30,0	39,0	30,0	38,0	29,0	
50	48,5	51,0				28,0	40,0	32,0	45,0	32,0	44,0	32,0	44,0	32,0	43,0	32,0	
55	53,5	56,0				36,0		35,0	50,0	35,0	49,0	37,0	49,0	37,0	48,0	37,0	
60	58,5	61,0						35,0	50,0	35,0	54,0	37,0	54,0	37,0	53,0	37,0	
65	63,5	66,0						40,0		37,5	59,0	42,0	59,0	41,0	58,0	41,0	
70	68,5	71,0								37,5	59,0	42,0	61,0	41,0	61,0	41,0	
75	73,5	76,0								37,5		42,0	61,0	41,0	61,0	41,0	
80	78,5	81,0								37,5		47,0	61,0	46,0	61,0	46,0	
90	88,5	91,5										47,0		61,0		61,0	
100	98,5	101,5												61,0		61,0	
110	108,5	111,5												69,0		68,0	
120	118,5	121,5												69,0		68,0	
130	128,0	132,0														68,0	
140	138,0	142,0														68,0	
150	148,0	152,0														68,0	
160	158,0	162,0														68,0	
Screws of Ø6,0 mm with partial thread additionally in length of 180 to 300 mm, in steps of 20 mm, LgT= 68,0 mm									Other thread lengths in the range ≥4xd1 to max. standard length permitted.								
Intermediate lengths on Ls possible																	
									Annex A1								

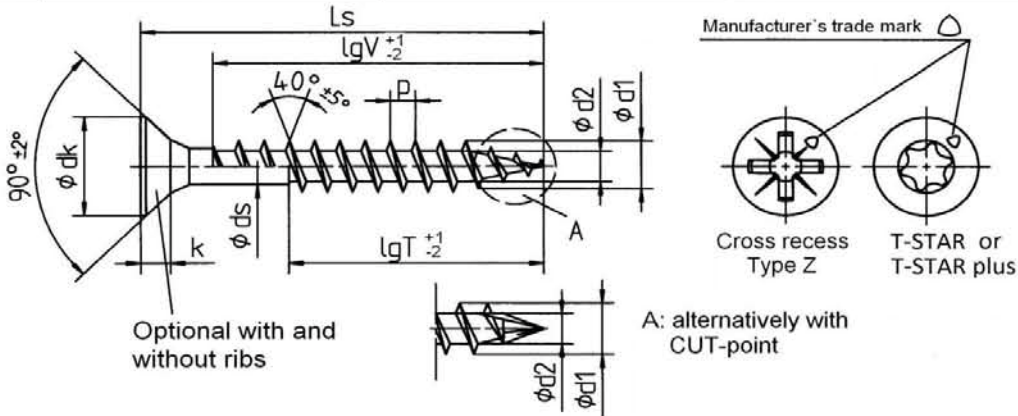
	SPAX®-S Flat countersunk head		Self-tapping screw with full and partial thread Material: cold rolled wire according to SPAX - Factory Standard Screws of high carbon steel								
											
Nominal diameter			7,0								
d1	thread size		7,0								
	permissible tolerance		±0,35								
dk	head diameter		13,1								
	permissible tolerance		±0,65								
d2	core diameter		4,5								
	permissible tolerance		±0,3								
ds	shank diameter		4,90								
	permissible tolerance		±0,10								
k	head height max.		3,8								
p	thread pitch		3,5								
	permissible tolerance		±0,1 x p								
T - STAR size			T30								
Cross recess size Type Z			3								
Ls			Standard thread lengths (full thread = lgV / partial thread = lgT)								
	Nom.dim.	min	max	lgV	lgT						
	40	38,5	41,0	33,0							
	45	43,5	46,0	38,0							
	50	48,5	51,0	43,0	33,0						
	55	53,5	56,0	48,0	33,0						
	60	58,5	61,0	53,0	38,0						
	65	63,5	66,0	58,0	38,0						
	70	68,5	71,0	61,0	43,0						
	75	73,5	76,0	68,0	43,0						
	80	78,5	81,0	68,0	48,0						
	90	88,5	91,5	68,0	53,0						
	100	98,5	101,5	68,0	58,0						
	110	108,5	111,5		68,0						
	120	118,5	121,5		68,0						
	130	128,0	132,0		68,0						
	140	138,0	142,0		68,0						
	150	148,0	152,0		68,0						
	160	158,0	162,0		68,0						
	180	178,0	182,0		68,0						
	200	198,0	202,0		68,0						
	<i>bis</i>										
	400	397,0	402,0		68,0						
Lengths over 200 mm to 400 mm in steps of 20 mm						Other thread lengths in the range ≥4xd1 to max. standard length permitted.					
Intermediate lengths on Ls possible											
Annex A2											

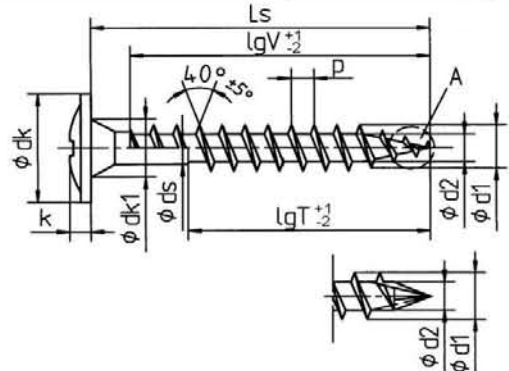
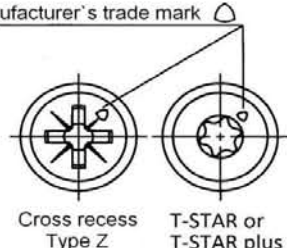
 SPAX®-S Washer head		Self-tapping screw with full and partial thread Material: cold rolled wire according to SPAX - Factory Standard Screws of high carbon steel												
						 Cross recess Type Z T-STAR or T-STAR plus A: alternatively with CUT-point								
Nominal diameter		3,0	3,5	4,0	4,5	5,0	6,0							
d1	thread size	3,1	3,5	4,0	4,5	5,0	6,0							
	permissible tolerance							±0,3						
dk	head diameter	7,9	8,6	9,6	10,6	11,6	13,6							
	permissible tolerance	±0,5			±0,6				±0,68					
dk1	contersink diameter	4,9	4,9	5,0	5,4	5,9	6,9							
	permissible tolerance							-0,2						
d2	core diameter	1,9	2,2	2,5	2,8	3,2	3,8							
	permissible tolerance	+0,15/-0,25	-0,30			±0,3								
ds	shank diameter	2,15	2,45	2,85	3,20	3,55	4,30							
	permissible tolerance							±0,10						
k	head height max.	1,5	1,8	1,9	2,0	2,2	2,4							
p	thread pitch	1,5	1,8	2,0	2,2	2,5	3,0							
	permissible tolerance							±0,1 x p						
T - STAR size		T10	T15 / T20	T20		T25	T30							
Cross recess size Type Z		2												
Ls	Standard thread lengths (full thread = lgV / partial thread = lgT)													
Nom.dim.	min	max	lgV	lgT	lgV	lgT	lgV	lgT	lgV	lgT	lgV	lgT	lgV	lgT
15	14,0	15,5	13,0											
16	16,0	17,5	15,0		15,0									
20	18,5	20,5	18,0	12,5	18,0		18,0							
25	23,5	25,5	23,0	18,0	23,0	18,0	18,0	17,0	22,5		22,0			
30	28,5	30,5	28,0	18,0	27,0	18,0	27,5	18,0	27,5		27,0		27,0	
35	33,5	36,0	33,0	23,0	32,0	23,0	32,5	23,0	32,5	25,0	32,0	25,0	32,0	24,0
40	38,5	41,0	36,0	23,0	37,0	23,0	37,5	23,0	37,0	25,0	37,0	27,0	37,0	24,0
45	43,5	46,0	36,0	28,0	40,0	30,0	42,5	30,0	42,0	30,0	41,0	30,0	41,0	29,0
50	48,5	51,0		28,0		32,0	47,5	32,5	47,0	32,5	46,0	32,0	46,0	32,0
55	53,5	56,0			36,0		35,0	50,0	35,0	52,0	37,0	51,0	37,0	37,0
60	58,5	61,0					35,0	50,0	35,0	57,0	37,0	56,0	37,0	37,0
65	63,5	66,0				40,0			37,5	59,0	42,0	61,0	41,0	41,0
70	68,5	71,0							37,5	59,0	42,0	61,0	41,0	41,0
75	73,5	76,0							37,5		42,0	61,0	41,0	41,0
80	78,5	81,0							37,5		47,0	61,0	46,0	46,0
90	88,5	91,5								47,0		61,0		61,0
100	98,5	101,5										61,0		61,0
110	108,5	111,5										69,0		68,0
120	118,5	121,5										69,0		68,0
130	128,0	132,0												68,0
140	138,0	142,0												68,0
150	148,0	152,0												68,0
160	158,0	162,0												68,0
Screws of Ø6,0 mm with partial thread additionally in length of 180 to 300 mm, in steps of 20 mm, LgT = 68,0 mm					Other thread lengths in the range ≥4xdl to max. standard length permitted.									
Intermediate lengths on Ls possible														
														Annex A3

 SPAX®-S Washer head		Self-tapping screw with full and partial thread Material: cold rolled wire according to SPAX - Factory Standard Screws of high carbon steel									
							Manufacturer's trade mark   Cross recess Type Z T-STAR or T-STAR plus A: alternatively with CUT-point				
Norminal diameter		7,0									
d1	thread size	7,0									
	permissible tolerance	±0,35									
dk	head diameter	18,0									
	permissible tolerance	±0,9									
dk1	contersink diameter	7,8									
	permissible tolerance	-0,30									
d2	core diameter	4,5									
	permissible tolerance	±0,3									
ds	shank diameter	4,90									
	permissible tolerance	±0,1									
k	head height max.	3,7									
p	thread pitch	3,5									
	permissible tolerance	±0,1 x p									
T - STAR size		T30									
Cross recess size Type Z		3									
Ls			Standard thread lengths (full thread = lgV / partial thread = lgT)								
Nom.dim.	min	max	lgV	lgT							
50	48,5	51,0	46,0	33,0							
55	53,5	56,0	51,0	33,0							
60	58,5	61,0	56,0	38,0							
65	63,5	66,0	61,0	38,0							
70	68,5	71,0	61,0	43,0							
75	73,5	76,0	68,0	43,0							
80	78,5	81,0	68,0	48,0							
90	88,5	91,5	68,0	53,0							
100	98,5	101,5	68,0	58,0							
110	108,5	111,5		68,0							
120	118,5	121,5		68,0							
130	128,0	132,0		68,0							
140	138,0	142,0		68,0							
150	148,0	152,0		68,0							
160	158,0	162,0		68,0							
180	178,0	182,0		68,0							
200	198,0	202,0		68,0							
<i>to</i>											
400	397,0	402,0		68,0							
Lengths over 200 mm to 400 mm in steps of 20 mm					Other thread lengths in the range ≥4xd1 to max. standard length permitted.						
Intermediate lengths on Ls possible											
Annex A4											

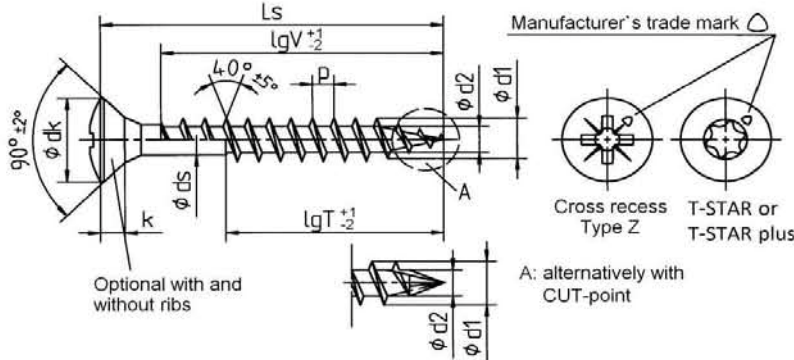
 SPAX[®]-S Raised countersunk head		Self-tapping screw with full and partial thread														
		Material: cold rolled wire according to SPAX - Factory Standard Screws of high carbon steel														
																
Norminal diameter		2,5	3,0	3,5	4,0	4,5	5,0	6,0								
d1	thread size	2,5	3,1	3,5	4,0	4,5	5,0	6,0								
	permissible tolerance							±0,3								
dk	head diameter	5,1	6,0	7,0	8,0	8,8	9,7	11,6								
	permissible tolerance							±0,5								
d2	core diameter	1,7	1,9	2,2	2,5	2,8	3,2	3,8								
	permissible tolerance	-0,30	+0,15/-0,25	-0,30					±0,3							
ds	shank diameter	1,8	2,15	2,45	2,85	3,20	3,55	4,30								
	permissible tolerance							±0,10								
k	head height max.	1,6	1,8	2,1	2,4	2,7	2,9	3,4								
p	thread pitch	1,3	1,5	1,8	2,0	2,2	2,5	3,0								
	permissible tolerance							±0,1 x p								
T - STAR size		T8	T10	T15 / T20	T20		T25	T30								
Cross recess size Type Z		1		2					3							
Ls	Standard thread lengths (full thread = lgV / partial thread = lgT)															
Nom. dim.	min	max	lgV	lgT	lgV	lgT	lgV	lgT	lgV	lgT	lgV	lgT	lgV	lgT	lgV	lgT
12	12,0	13,5	10,0													
15	14,0	15,5	12,0		12,5											
16	16,0	17,5	14,0		14,0											
20	18,5	20,5	17,0	12,0	17,0	12,5	16,0		16,0							
25	23,5	25,5	22,0	18,0	22,0	18,0	21,0	18,0	21,0		20,0		20,0			
30	28,5	30,5		18,0	26,0	18,0	25,0	18,0	25,0	18,0	25,0		25,0		24,0	
35	33,5	36,0		22,0	31,0	23,0	30,0	23,0	30,0	22,5	30,0	25,0	30,0	25,0	29,0	
40	38,5	41,0		22,0	36,0	23,0	35,0	23,0	35,0	22,5	34,0	25,0	35,0	27,0	34,0	24,0
45	43,5	46,0		28,0	36,0	28,0	40,0	30,0	40,0	30,0	39,0	30,0	39,0	30,0	38,0	29,0
50	48,5	51,0				28,0	40,0	32,0	45,0	32,0	44,0	32,0	44,0	32,0	43,0	32,0
55	53,5	56,0				36,0		35,0	50,0	35,0	49,0	37,0	49,0	37,0	48,0	37,0
60	58,5	61,0						35,0	50,0	35,0	54,0	37,0	54,0	37,0	53,0	37,0
65	63,5	66,0						40,0		37,5	59,0	42,0	59,0	41,0	58,0	41,0
70	68,5	71,0								37,5	59,0	42,0	61,0	41,0	61,0	41,0
75	73,5	76,0								37,5		42,0	61,0	41,0	61,0	41,0
80	78,5	81,0								37,5		47,0	61,0	46,0	61,0	46,0
90	88,5	91,5										47,0		61,0		61,0
100	98,5	101,5												61,0		61,0
110	108,5	111,5													69,0	68,0
120	118,5	121,5													69,0	68,0
130	128,0	132,0														68,0
140	138,0	142,0														68,0
150	148,0	152,0														68,0
160	158,0	162,0														68,0
Screws of Ø6,0 mm with partial thread additionally in length of 180 to 300 mm, in steps of 20 mm, LgT= 68,0 mm		Other thread lengths in the range ≥4xd1 to max. standard length permitted.														
Intermediate lengths on Ls possible																
Annex A5																

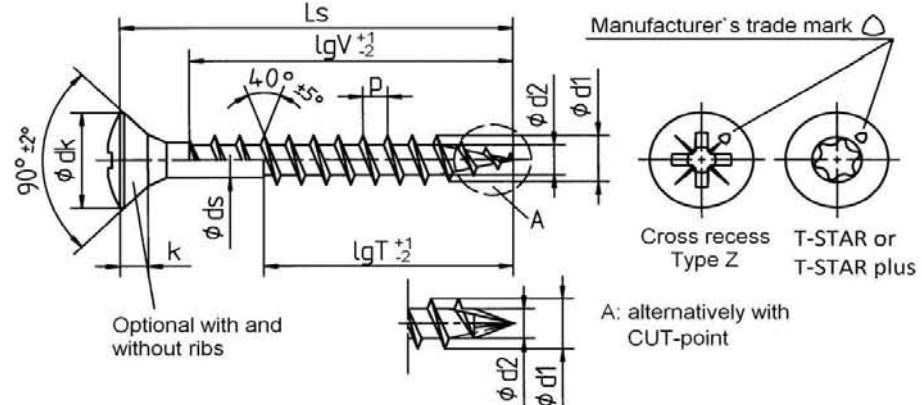
 SPAX®-S Raised countersunk head		Self-tapping screw with full and partial thread									
		Material: cold rolled wire according to SPAX - Factory Standard Screws of high carbon steel									
											
Norminal diameter		7,0									
d1	thread size	7,0									
	permissible tolerance	±0,35									
dk	head diameter	13,1									
	permissible tolerance	±0,65									
d2	core diameter	4,5									
	permissible tolerance	±0,3									
ds	shank diameter	4,90									
	permissible tolerance	±0,10									
k	head height max.	3,8									
p	thread pitch	3,5									
	permissible tolerance	±0,1 x p									
T - STAR size		T30									
Cross recess size Type Z		3									
Ls		Standard thread lengths (full thread = lgV / partial thread = lgT)									
Nom.dim.	min	max	lgV	lgT							
40	38,5	41,0	33,0								
45	43,5	46,0	38,0								
50	48,5	51,0	43,0	33,0							
55	53,5	56,0	48,0	33,0							
60	58,5	61,0	53,0	38,0							
65	63,5	66,0	58,0	38,0							
70	68,5	71,0	61,0	43,0							
75	73,5	76,0	68,0	43,0							
80	78,5	81,0	68,0	48,0							
90	88,5	91,5	68,0	53,0							
100	98,5	101,5	68,0	58,0							
110	108,5	111,5		68,0							
120	118,5	121,5		68,0							
130	128,0	132,0		68,0							
140	138,0	142,0		68,0							
150	148,0	152,0		68,0							
160	158,0	162,0		68,0							
180	178,0	182,0		68,0							
200	198,0	202,0		68,0							
to											
400	397,0	402,0		68,0							
Lengths over 200 mm to 400 mm in steps of 20 mm						Other thread lengths in the range ≥4xd1 to max. standard length permitted.					
Intermediate lengths on Ls possible											
Annex A6											

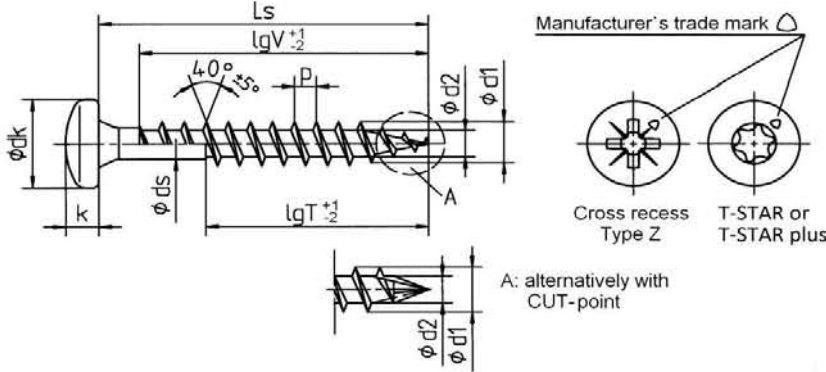
 SPAX®-S Pan head		Self-tapping screw with full and partial thread																
		Material: cold rolled wire according to SPAX - Factory Standard Screws of high carbon steel																
																		
Nominal diameter		2,5	3,0	3,5	4,0	4,5	5,0	6,0										
d1	thread size	2,5	3,1	3,5	4,0	4,5	5,0	6,0										
	permissible tolerance								±0,3									
dk	head diameter	5,0	6,0	7,0	8,0	9,0	9,9	11,9										
	permissible tolerance							±0,5		±0,6								
d2	core diameter	1,7	1,9	2,2	2,5	2,8	3,2	3,8										
	permissible tolerance	-0,30	+0,15/-0,25		-0,30	±0,3												
ds	shank diameter	1,8	2,15	2,45	2,85	3,20	3,55	4,30										
	permissible tolerance								±0,10									
k	head height max.	2,1	2,3	2,7	2,9	3,1	3,4	4,0										
p	thread pitch	1,3	1,5	1,8	2,0	2,2	2,5	3,0										
	permissible tolerance								±0,1 x p									
T-STAR	size	T8	T10	T15 / T20	T20			T25	T30									
Cross recess size Type Z		1			2				3									
Ls		Standard thread lengths (full thread = lgV / partial thread = lgT)																
Nom. dim.	min	max	lgV	lgT	lgV	lgT	lgV	lgT	lgV	lgT	lgV	lgT	lgV	lgT	lgV	lgT		
12	12,0	13,5	12,0															
15	14,0	15,5	13,0		13,0													
16	16,0	17,5	15,0		15,0		15,0											
20	18,5	20,5	18,0	12,0	18,0		18,0		18,0									
25	23,5	25,5	23	18,0	23,0		23,0	18,0	23,0		22,5	22,0						
30	28,5	30,5	28,0	18,0	28,0	18,0	27,0	18,0	27,5	18,0	27,5		27,0	27,0				
35	33,5	36,0		22,0	33,0	23,0	32,0	23,0	32,5	23,0	32,5	25,0	32,0	25,0	32,0	24,0		
40	38,5	41,0		22,0	36,0	23,0	37,0	23,0	37,5	23,0	37,0	25,0	37,0	27,0	37,0	24,0		
45	43,5	46,0		28,0	36,0	28,0		30,0	42,5	30,0	42,0	30,0	41,0	30,0	41,0	29,0		
50	48,5	51,0				28,0		32,0	47,5	32,5	47,0	32,5	46,0	32,0	46,0	32,0		
55	53,5	56,0				36,0		35,0	50,0	35,0	52,0	37,0	51,0	37,0	51,0	37,0		
60	58,5	61,0						35,0	50,0	35,0	57,0	37,0	56,0	37,0	56,0	37,0		
65	63,5	66,0						40,0		37,5	59,0	42,0	61,0	41,0	60,0	41,0		
70	68,5	71,0								37,5	59,0	42,0	61,0	41,0	60,0	41,0		
75	73,5	76,0								37,5		42,0	61,0	41,0	60,0	41,0		
80	78,5	81,0								37,5		47,0	61,0	46,0	60,0	46,0		
90	88,5	91,5										47,0		61,0		61,0		
100	98,5	101,5												61,0		61,0		
110	108,5	111,5													69,0	68,0		
120	118,5	121,5													69,0	68,0		
130	128,0	132,0														68,0		
140	138,0	142,0														68,0		
150	148,0	152,0														68,0		
160	158,0	162,0														68,0		
Screws of Ø6,0 mm with partial thread additionally in length of 180 to 300 mm, in steps of 20 mm, LgT= 68,0 mm									Other thread lengths in the range ≥4xd1 to max. standard length permitted.									
Intermediate lengths on Ls possible																		
Annex A7																		

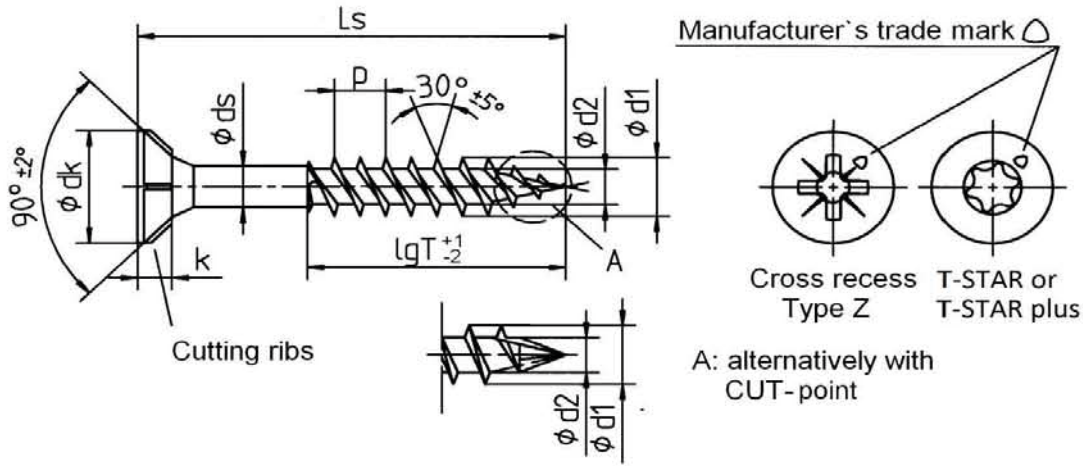

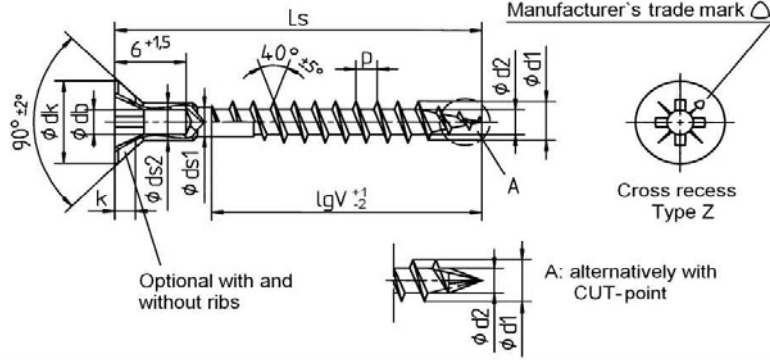
 SPAX®-S Countersunk head with cutting ribs		Self-tapping screw with double thread Material: cold rolled wire according to SPAX - Factory standard Screws of high carbon steel						
								
Norminal diameter					4,0	4,5		
d1	thread size			4,0	4,5			
	permissible tolerance			±0,3				
dk	head diameter			8,0	8,8			
	permissible tolerance			±0,5	±0,6			
d2	core diameter			2,5	2,8			
	permissible tolerance			±0,3				
ds	shank diameter			2,85	3,20			
	permissible tolerance			±0,10				
k	head height max.			2,4	2,7			
p	thead pitch			3,3	3,5			
	permissible tolerance			±0,1 x p				
T - STAR	size			T20				
Cross recess	size Type Z			2				
Ls			Standard thread lengths (partial thread = lgT)					
Nom. dim.	min	max		lgT	lgT			
35	33,5	36,0		22,5	24,0			
40	38,5	41,0		22,5	24,0			
45	43,5	46,0		30,0	29,0			
50	48,5	51,0		30,0	29,0			
55	53,5	56,0		35,0	34,0			
60	58,5	61,0		35,0	34,0			
65	63,5	66,0		37,5	42,0			
70	68,5	71,0		37,5	42,0			
75	73,5	76,0		50,0	49,0			
80	78,5	81,0			49,0			
90	88,5	91,5			49,0			
Intermediate lengths on Ls possible				Other thread lengths in the range ≥4xd1 to max. standard length permitted				
Annex A9								

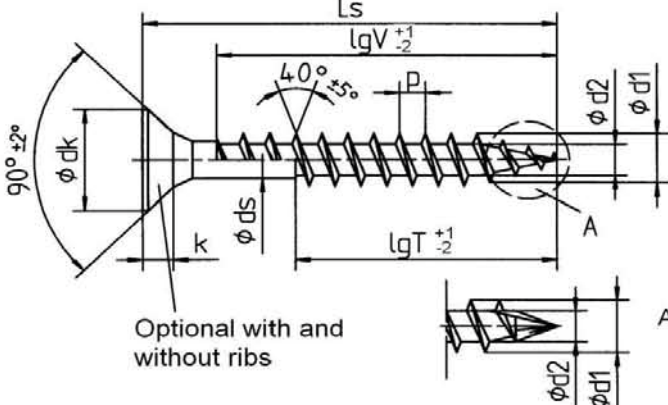
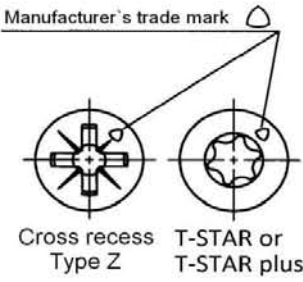
 SPAX®-S Countersunk with head hole		Self-tapping screw with full thread Material: cold rolled wire according to SPAX - Factory Standard Screws of high carbon steel						
								
Nominal diameter					4,0	4,5	5,0	6,0
d1	thread size				4,0	4,5	5,0	6,0
	permissible tolerance				± 0,3			
dk	head diameter				8,0	8,8	9,7	11,6
	permissible tolerance				±0,5		±0,6	
db	hole diameter				2,50			
	permissible tolerance				± 0,15			
d2	core diameter				2,5	2,8	3,2	3,8
	permissible tolerance				±0,3			
ds1	shank diameter				2,85	3,20	3,55	4,30
	permissible tolerance				± 0,10			
ds2	shank diameter				3,60	3,80	4,10	ohne
	permissible tolerance				±0,10		±0,2	
k	head height max.				2,4	2,7	2,9	3,4
p	thread pitch				2,0	2,2	2,5	3,0
	permissible tolerance				± 0,1 x p			
Cross recess size Z					2			3
Ls		Standard thread lengths (full thread = lgV)						
Nom. dim.	min	max			lgV	lgV	lgV	lgV
25	23,5	26,0			18,0			
30	28,5	31,0			23,0	20,0		
35	33,5	36,0			27,5	25,0		
40	38,5	41,0			32,5	30,0	30,0	
45	43,5	46,0			37,5	34,0	35,0	
50	48,5	51,0			42,5	39,0	39,0	41,0
55	53,5	56,0			47,5	44,0	44,0	46,0
60	58,5	61,0			50,0	49,0	49,0	51,0
65	63,5	66,0				54,0	54,0	56,0
70	68,5	71,0				59,0	61,0	61,0
75	73,5	76,0				59,0	61,0	61,0
80	78,5	81,0				59,0	61,0	61,0
90	88,5	91,5				59,0	61,0	61,0
100	98,5	101,5					61,0	61,0
110	108,5	111,5					69,0	68,0
120	118,5	121,5					69,0	68,0
130	128,0	132,0						68,0
140	138,0	142,0						68,0
150	148,0	152,0						68,0
160	158,0	162,0						68,0
Screw of Ø 6,0 mm with partial thread additionally in lengths of 180 to 300 mm , in steps of 20 mm, lgV = 68,0 mm					Other thread lengths in the range ≥4xd1 to max. standard length permitted			
Intermediate lengths on Ls possible								
Annex A10								

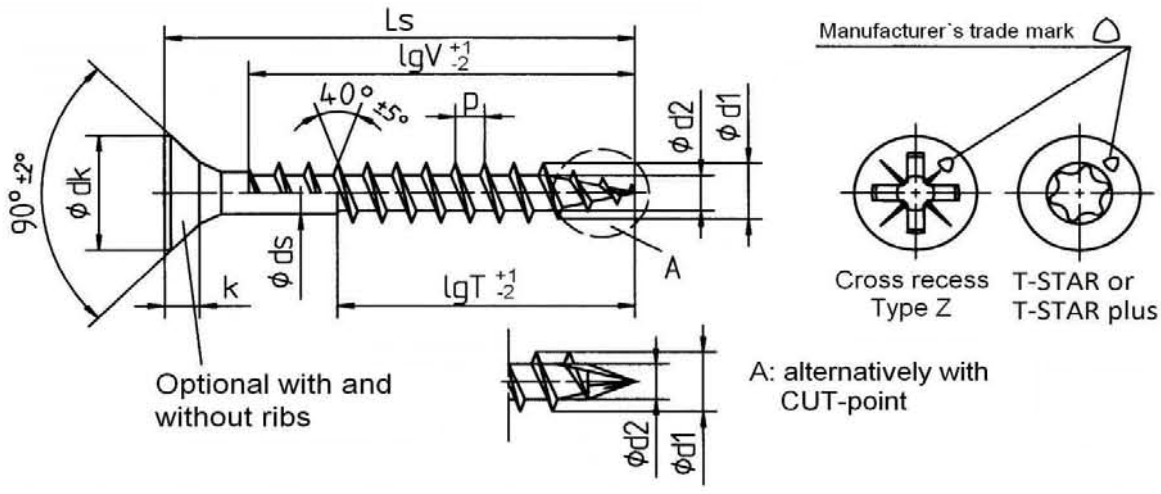
 SPAX®-S Flat countersunk head		Self-tapping screw with full and partial thread														
		Material: cold rolled wire according to SPAX - Factory Standard Stainless steel screws														
						A: alternatively with CUT-point										
Nominal diameter			3,0	3,5	4,0	4,5	5,0	6,0								
d1	thread size		3,0	3,5	4,0	4,5	5,1	6,1								
	permissible tolerance		±0,3													
dk	head diameter		6,0	7,0	8,0	8,8	9,7	11,6								
	permissible tolerance		±0,5													
d2	core diameter		2,1	2,4	2,8	3,0	3,4	3,8								
	permissible tolerance		-0,30	±0,3												
ds	shank diameter		2,25	2,60	3,00	3,30	3,75	4,30								
	permissible tolerance		±0,10													
k	head height max.		1,8	2,1	2,4	2,7	2,9	3,4								
p	thread pitch		1,5	1,8	2,0	2,2	2,5	3,0								
	permissible tolerance		±0,1 x p													
T-STAR	size		T10	T15 / T20	T20		T25	T30								
Cross recess	size Type Z		1	2				3								
Ls		Standard thread lengths (full thread = lgV / partial thread = lgT)														
Nom. dim.	min	max	lgV	lgT	lgV	lgT	lgV	lgT	lgV	lgT	lgV	lgT	lgV	lgT	lgV	lgT
15	14,0	15,5			12,5											
16	16,0	17,5			14,0											
20	18,5	20,5			17,0		16,0		16,0							
25	23,5	25,5			21,0	18,0	21,0	18,0	21,0		20,0		20,0			
30	28,5	30,5			26,0	18,0	25,0	18,0	25,0	18,0	25,0		25,0		24,0	
35	33,5	36,0			31,0	23,0	30,0	23,0	30,0	23,0	30,0	25,0	30,0	25,0	29,0	24,0
40	38,5	41,0			36,0	23,0	35,0	23,0	35,0	23,0	34,0	25,0	35,0	27,0	34,0	24,0
45	43,5	46,0			36,0	28,0	40,0	30,0	40,0	30,0	39,0	30,0	39,0	30,0	38,0	29,0
50	48,5	51,0				28,0	40,0	32,0	45,0	32,0	44,0	32,0	44,0	32,0	43,0	32,0
55	53,5	56,0				36,0		35,0	50,0	35,0	49,0	37,0	49,0	37,0	48,0	37,0
60	58,5	61,0						35,0	50,0	35,0	54,0	37,0	54,0	37,0	53,0	37,0
65	63,5	66,0						40,0		37,5	59,0	42,0	59,0	41,0	58,0	41,0
70	68,5	71,0								37,5	59,0	42,0	61,0	41,0	61,0	41,0
75	73,5	76,0								37,5		42,0	61,0	41,0	61,0	41,0
80	78,5	81,0								37,5		47,0	61,0	46,0	61,0	46,0
90	88,5	91,5									47,0		61,0		61,0	
100	98,5	101,5											61,0		61,0	
110	108,5	111,5											69,0		68,0	
120	118,5	121,5											69,0		68,0	
130	128,0	132,0													68,0	
140	138,0	142,0													68,0	
150	148,0	152,0													68,0	
160	158,0	162,0													68,0	
Intermediate lengths on Ls possible		Other thread lengths in the range ≥4xd1 to max. standard length permitted.														
Annex A11																

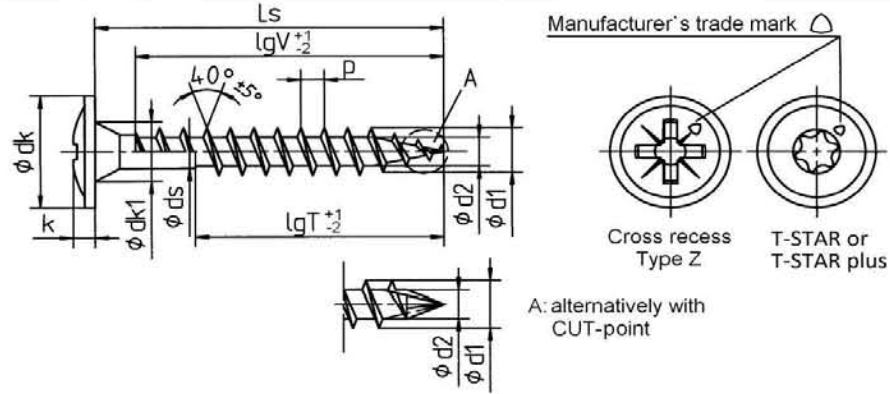
 SPAX®-S Flat countersunk head		Self-tapping screw with full and partial thread Material: cold rolled wire according to SPAX - Factory Standard Stainless steel screws									
											
Nominal diameter		7,0									
d1	thread size	7,1									
	permissible tolerance	±0,35									
dk	head diameter	13,1									
	permissible tolerance	±0,65									
d2	core diameter	4,5									
	permissible tolerance	±0,3									
ds	shank diameter	4,90									
	permissible tolerance	±0,10									
k	head height max.	3,8									
p	thread pitch	3,5									
	permissible tolerance	±0,1 x p									
T - STAR size		T30									
Cross recess size Type Z		3									
Ls		Standard thread lengths (full thread = lgV / partial thread = lgT)									
Nom.dim.	min	max	lgV	lgT							
40	38,5	41,0	33,0								
45	43,5	46,0	38,0								
50	48,5	51,0	43,0	33,0							
55	53,5	56,0	48,0	33,0							
60	58,5	61,0	53,0	38,0							
65	63,5	66,0	58,0	38,0							
70	68,5	71,0	61,0	43,0							
75	73,5	76,0	68,0	43,0							
80	78,5	81,0	68,0	48,0							
90	88,5	91,5	68,0	53,0							
100	98,5	101,5	68,0	58,0							
110	108,5	111,5		68,0							
120	118,5	121,5		68,0							
Intermediate lengths on Ls possible						Other thread lengths in the range ≥4xd1 to max. standard length permitted.					
Annex A12											

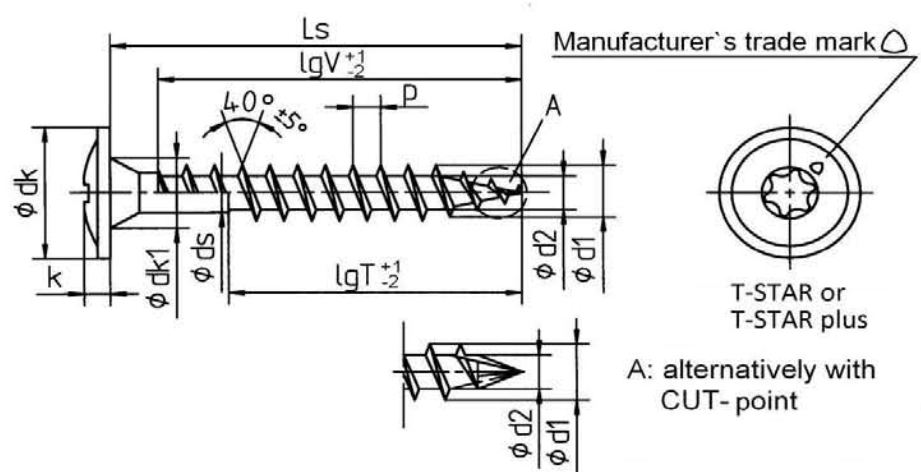
		Self-tapping screw with full and partial thread												
		Material: cold rolled wire according to SPAX - Factory Standard Stainless steel screws												
														
Nominal diameter			3,0	3,5	4,0	4,5	5,0	6,0						
d1	thread size		3,0	3,5	4,0	4,5	5,1	6,1						
	permissible tolerance							±0,3						
dk	head diameter		7,9	8,6	9,6	10,6	11,6	13,6						
	permissible tolerance		±0,5					±0,6						
dk1	contersink diameter		4,9	4,9	5,0	5,4	5,9	6,9						
	permissible tolerance							+0,20						
d2	core diameter		2,1	2,4	2,8	3,0	3,4	3,8						
	permissible tolerance		-0,30					±0,3						
ds	shank diameter		2,25	2,60	3,00	3,30	3,75	4,30						
	permissible tolerance							+0,10						
k	head height max.		1,5	1,8	1,9	2,0	2,2	2,4						
p	thread pitch		1,5	1,8	2,0	2,2	2,5	3,0						
	permissible tolerance							±0,1 x p						
T - STAR size			T10	T15 / T20	T20			T25	T30					
Cross recess size Type Z			2											
Ls		Standard thread lengths (full thread = lgV / partial thread = lgT)												
Nom.dim.	min	max	lgV	lgT	lgV	lgT	lgV	lgT	lgV	lgT	lgV	lgT	lgV	lgT
12	12,0	13,5	13,0											
15	16,0	17,5	14,0											
16	16,0	17,5	15,0		15,0									
20	18,5	20,5	18,0	12,5	18,0		18,0							
25	23,5	25,5	23,0	18,0	23,0	18,0	23,0		22,5		22,0			
30	28,5	30,5	28,0	18,0	27,0	18,0	27,5	18,0	27,5		27,0		27,0	
35	33,5	36,0	33,0	23,0	32,0	23,0	32,5	23,0	32,5	25,0	32,0	25,0	32,0	24,0
40	38,5	41,0	36,0	23,0	37,0	23,0	37,5	23,0	37,0	25,0	37,0	27,0	37,0	24,0
45	43,5	46,0	36,0	28,0	30,0	30,0	42,5	30,0	42,0	30,0	41,0	30,0	41,0	29,0
50	48,5	51,0		28,0		32,0	47,5	32,5	47,0	32,5	46,0	32,0	46,0	32,0
55	53,5	56,0		36,0		35,0	50,0	35,0	52,0	37,0	51,0	37,0	51,0	37,0
60	58,5	61,0				35,0	50,0	35,0	57,0	37,0	56,0	37,0	56,0	37,0
65	63,5	66,0				40,0		37,5	59,0	42,0	61,0	41,0	61,0	41,0
70	68,5	71,0						37,5	59,0	42,0	61,0	41,0	61,0	41,0
75	73,5	76,0						37,5		42,0	61,0	41,0	61,0	41,0
80	78,5	81,0						37,5	47,0	47,0	61,0	46,0	61,0	46,0
90	88,5	91,5							47,0		61,0		61,0	
100	98,5	101,5									61,0		61,0	
110	108,5	111,5									69,0		68,0	
120	118,5	121,5									69,0		68,0	
130	128,5	131,5											68,0	
140	138,5	141,5											68,0	
150	148,5	151,5											68,0	
160	158,5	161,5											68,0	
Intermediate lengths on Ls possible						Other thread lengths in the range ≥4xd1 to max. standard length permitted.								
Annex A13														

 SPAX®-S Washer head		Self-tapping screw with full and partial thread Material: cold rolled wire according to SPAX - Factory Standard Stainless steel screw									
		 <p>Manufacturer's trade mark </p> <p>T-STAR or T-STAR plus</p> <p>A: alternatively with CUT-point</p>									
Norminal diameter		7,0									
d1	thread size	7,1									
	permissible tolerance	±0,35									
dk	head diameter	18,0									
	permissible tolerance	±0,9									
dk1	contersink diameter	7,8									
	permissible tolerance	-0,30									
d2	core diameter	4,5									
	permissible tolerance	±0,3									
ds	shank diameter	4,90									
	permissible tolerance	±0,10									
k	head height max.	3,7									
p	thread pitch	3,5									
	permissible tolerance	±0,1 x p									
T - STAR	size	T30									
Ls		Standard thread lengths (full thread = lgV / partial thread = lgT)									
Nom.dim.	min	max	lgV	lgT							
50	48,5	51,0	46,0	33,0							
55	53,5	56,0	51,0	33,0							
60	58,5	61,0	56,0	38,0							
65	63,5	66,0	61,0	38,0							
70	68,5	71,0	61,0	43,0							
75	73,5	76,0	68,0	43,0							
80	78,5	81,0	68,0	48,0							
90	88,5	91,5	68,0	53,0							
100	98,5	101,5	68,0	58,0							
110	108,5	111,5		68,0							
120	118,5	121,5		68,0							
Intermediate lengths on Ls possible					Other thread lengths in the range $\geq 4 \times d1$ to max. standard length permitted.						
Annex A14											



SPAX®-S
Raised countersunk head

Self-tapping screw with full and partial thread

Material: cold rolled wire according to SPAX - Factory Standard

Stainless steel screws

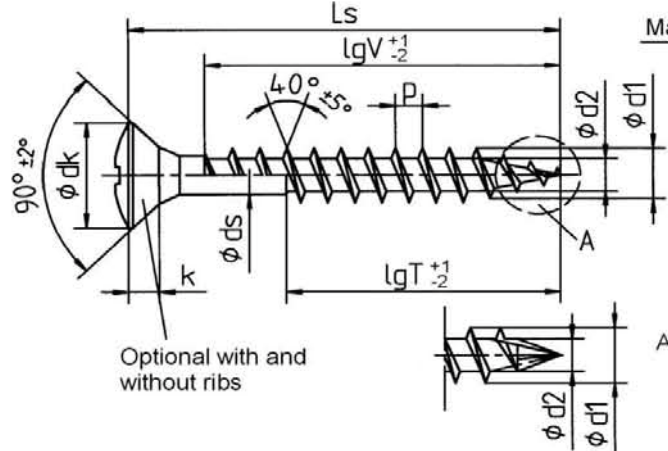

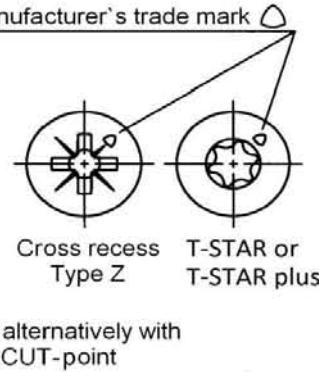







Nominal diameter		3,0	3,5	4,0	4,5	5,0	6,0
d1	thread size	3,0	3,5	4,0	4,5	5,1	6,1
	permissible tolerance	±0,3					
dk	head diameter	6,0	7,0	8,0	8,8	9,7	11,6
	permissible tolerance	±0,5					
d2	core diameter	2,1	2,4	2,8	3,0	3,4	3,8
	permissible tolerance	-0,30					
ds	shank diameter	2,25	2,60	3,00	3,30	3,75	4,30
	permissible tolerance	±0,10					
k	head hight max.	1,8	2,1	2,4	2,7	2,9	3,4
p	thread pitch	1,5	1,8	2,0	2,2	2,5	3,0
	permissible tolerance	±0,1 x p					
T - STAR size		T10	T15 / T20	T20		T25	T30
Cross recess size Type Z		1	2				3

Ls	Standard thread lengths (full thread = lgV / partial thread = lgT)														
	Nom. dim.	min	max	lgV	lgT	lgV	lgT	lgV	lgT	lgV	lgT	lgV	lgT	lgV	lgT
15	14,0	15,5	12,5												
16	16,0	17,5	14,0												
20	18,5	20,5	17,0	12,5	16,0		16,0								
25	23,5	25,5	22,0	18,0	21,0	18,0	21,0	20,0		20,0					
30	28,5	30,5	26,0	18,0	25,0	18,0	25,0	18,0	25,0	25,0		25,0		24,0	
35	33,5	36,0	31,0	23,0	30,0	23,0	30,0	23,0	30,0	25,0	30,0	25,0	30,0	29,0	24,0
40	38,5	41,0	36,0	23,0	35,0	23,0	35,0	23,0	34,0	25,0	35,0	27,0	34,0	24,0	
45	43,5	46,0	36,0	28,0	40,0	30,0	40,0	30,0	39,0	30,0	39,0	30,0	38,0	29,0	
50	48,5	51,0		28,0	40,0	32,0	45,0	32,5	44,0	32,5	44,0	32,0	43,0	32,0	
55	53,5	56,0		36,0		35,0	50,0	35,0	49,0	37,0	49,0	37,0	48,0	37,0	
60	58,5	61,0				35,0	50,0	35,0	54,0	37,0	54,0	37,0	53,0	37,0	
65	63,5	66,0				40,0		37,5	59,0	42,0	59,0	41,0	58,0	41,0	
70	68,5	71,0						37,5	59,0	42,0	61,0	41,0	61,0	41,0	
75	73,5	76,0						37,5		42,0	61,0	41,0	61,0	41,0	
80	78,5	81,0						37,5		47,0	61,0	46,0	61,0	46,0	
90	88,5	91,5								47,0		61,0		61,0	
100	98,5	101,5										61,0		61,0	
110	108,5	111,5										69,0		68,0	
120	118,5	121,5										69,0		68,0	
130	128,0	132,0												68,0	
140	138,0	142,0												68,0	
150	148,0	152,0												68,0	
160	158,0	162,0												68,0	

Intermediate lengths on Ls possible

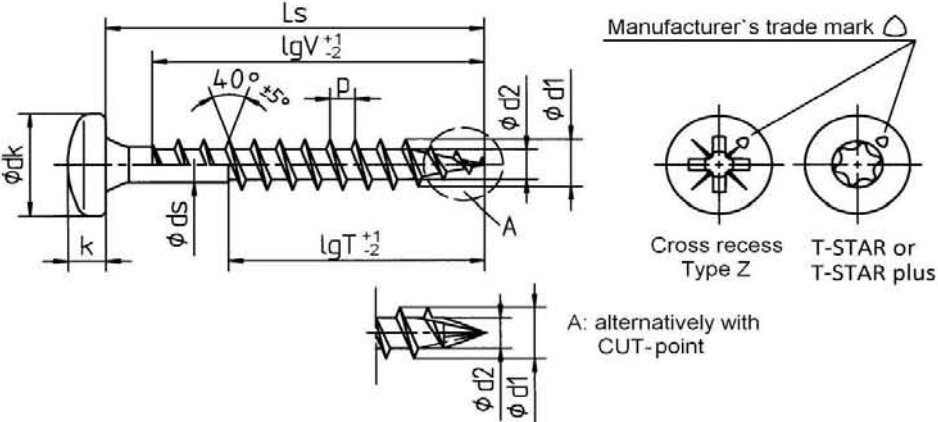
Other thread lengths in the range ≥4xd1 to max. standard length permitted.

Annex A15

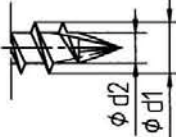
	 Pan head		Self-tapping screw with full and partial thread Material: cold rolled wire according to SPAX - Factory Standard Stainless steel screws															
											Manufacturer's trade mark   Cross recess Type Z  T-STAR or T-STAR plus A: alternatively with CUT-point 							
Nominal diameter			3,0		3,5		4,0		4,5		5,0		6,0					
d1	thread size		3,0		3,5		4,0		4,5		5,1		6,1					
	permissible tolerance		±0,3															
dk	head diameter		6,0		7,0		8,0		9,0		9,9		11,9					
	permissible tolerance		±0,5				±0,6											
d2	core diameter		2,1		2,4		2,8		3,0		3,4		3,8					
	permissible tolerance		-0,30		±0,3													
ds	shank diameter		2,25		2,60		3,00		3,30		3,75		4,30					
	permissible tolerance		±0,10															
k	head height max.		2,3		2,5		2,9		3,1		3,4		4,0					
p	thread pitch		1,5		1,8		2,0		2,2		2,5		3,0					
	permissible tolerance		±0,1 x p															
T - STAR size			T10		T15 / T20		T20		T25		T30							
Cross recess size Type Z			1		2		3											
Ls			Standard thread lengths (full thread = lgV / partial thread = lgT)															
Nom. dim.	min	max	lgV	lgT	lgV	lgT	lgV	lgT	lgV	lgT	lgV	lgT	lgV	lgT	lgV	lgT		
15	14,0	15,5	13,0															
16	16,0	17,5	15,0		15,0													
20	18,5	20,5	18,0	12,5	18,0		18,0											
25	23,5	25,5	23,0	18,0	23,0	18,0	23,0		22,5		22,0							
30	28,5	30,5	28,0	18,0	27,0	18,0	27,5	18,0	27,5		27,0		27,0					
35	33,5	36,0	33,0	23,0	32,0	23,0	32,5	23,0	32,5	25,0	32,0	25,0	32,0	24,0				
40	38,5	41,0	36,0	23,0	37,0	23,0	37,5	23,0	37,0	25,0	37,0	27,0	37,0	24,0				
45	43,5	46,0	36,0	28,0		30,0	42,5	30,0	42,0	30,0	41,0	30,0	41,0	29,0				
50	48,5	51,0		28,0		32,0	47,5	32,5	47,0	32,5	46,0	32,0	46,0	32,0				
55	53,5	56,0		36,0		35,0	50,0	35,0	52,0	37,0	51,0	37,0	51,0	37,0				
60	58,5	61,0				35,0	50,0	35,0	57,0	37,0	56,0	37,0	56,0	37,0				
65	63,5	66,0				40,0			37,5	59,0	42,0	61,0	41,0	60,0	41,0			
70	68,5	71,0							37,5	59,0	42,0	61,0	41,0	60,0	41,0			
75	73,5	76,0							37,5		42,0	61,0	41,0	60,0	41,0			
80	78,5	81,0							37,5		47,0	61,0	46,0	60,0	46,0			
90	88,5	91,5									47,0		61,0		61,0			
100	98,5	101,5											61,0		61,0			
110	108,5	111,5											69,0		68,0			
120	118,5	121,5											69,0		68,0			
130	128,0	132,0													68,0			
140	138,0	142,0													68,0			
150	148,0	152,0													68,0			
160	158,0	162,0													68,0			
Intermediate lengths on Ls possible										Other thread lengths in the range ≥4xd1 to max. standard length permitted.								
Annex A17																		

	SPAX®-S Pan head	Self-tapping screw with full and partial thread Material: cold rolled wire according to SPAX - Factory Standard Stainless steel screws
---	----------------------------	--

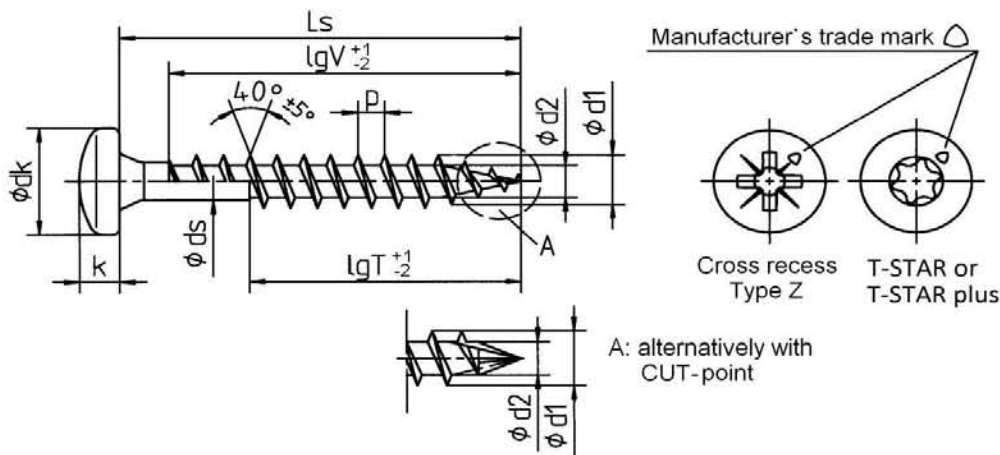





Nominal diameter	7,0								
d1	thread size	7,1							
	permissible tolerance	±0,35							
dk	head diameter	13,5							
	permissible tolerance	±0,65							
d2	core diameter	4,5							
	permissible tolerance	±0,3							
ds	shank diameter	4,90							
	permissible tolerance	±0,10							
k	head height max.	5							
p	thread pitch	3,5							
	permissible tolerance	±0,1 x p							
T - STAR	size	T30							
Cross recess size Type Z		3							



Ls			Standard thread lengths (full thread = lgV / partial thread = lgT)						
Nom. dim.	min	max	lgV	lgT					
50	48,5	51,0	46,0	33,0					
55	53,5	56,0	51,0	33,0					
60	58,5	61,0	56,0	38,0					
65	63,5	66,0	61,0	38,0					
70	68,5	71,0	61,0	43,0					
75	73,5	76,0	68,0	43,0					
80	78,5	81,0	68,0	48,0					
90	88,5	91,5	68,0	53,0					
100	98,5	101,5	68,0	58,0					
110	108,5	111,5		68,0					
120	118,5	121,5		68,0					

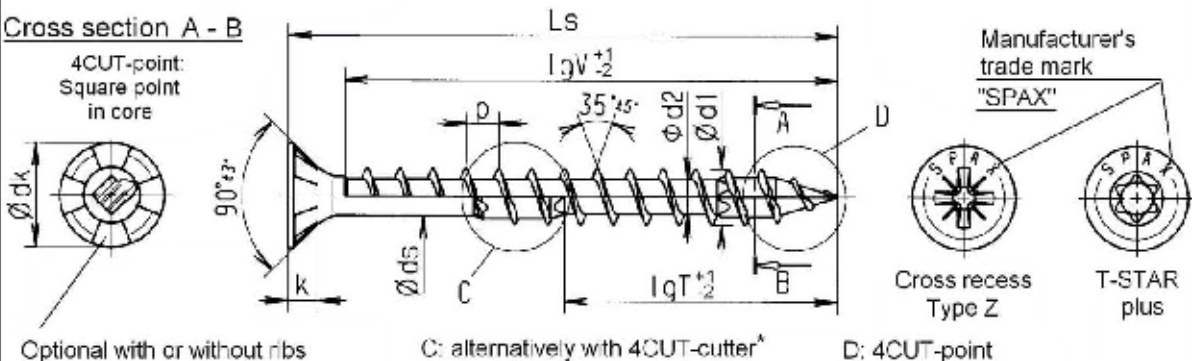

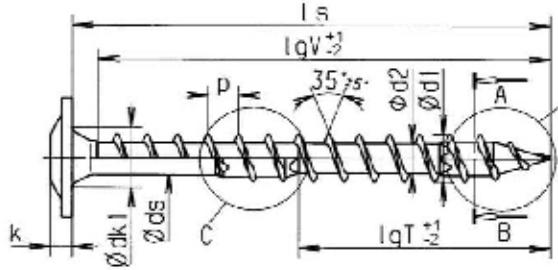

Intermediate lengths on Ls possible



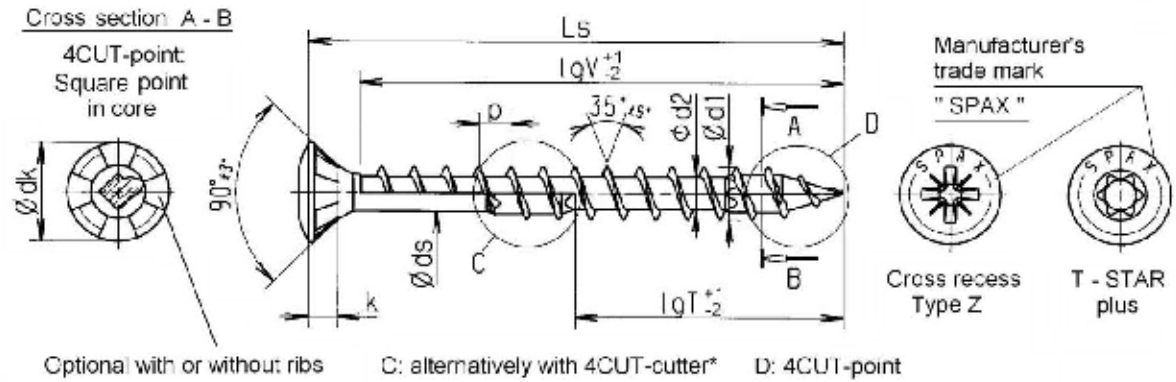

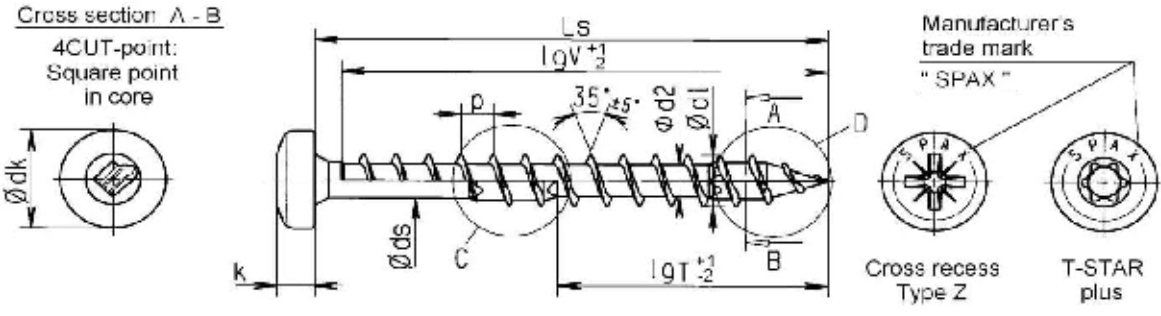
Other thread lengths in the range $\geq 4 \times d1$ to max. standard length permitted.

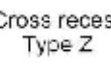

		Self-tapping screw with full and partial thread																																																																																																																																																																																																																																																																																																																																											
	Flat countersunk head	Material: cold rolled wire according to SPAX - factory Standard Screws of high carbon steel																																																																																																																																																																																																																																																																																																																																											
<p>Cross section A - B</p>  <p>4CUT-point: Square point in core 90°±3° Optional with or without ribs C: alternatively with 4CUT-cutter^a D: 4CUT-point Manufacturer's trade mark "SPAX" Cross recess Type Z T-STAR plus</p>																																																																																																																																																																																																																																																																																																																																													
<table border="1"> <tr> <td>Nominal diameter</td> <td></td> <td></td> <td></td> <td>3,5</td> <td>4,0</td> <td>4,5</td> <td>5,0</td> <td>6,0</td> </tr> <tr> <td>d</td> <td>thread size</td> <td></td> <td></td> <td>3,5</td> <td>4,0</td> <td>4,5</td> <td>5,0</td> <td>6,0</td> </tr> <tr> <td></td> <td>permissible tolerance</td> <td></td> <td></td> <td></td> <td></td> <td>-0,3</td> <td></td> <td></td> </tr> <tr> <td>dk</td> <td>head diameter</td> <td></td> <td></td> <td>7,0</td> <td>8,0</td> <td>8,8</td> <td>9,6</td> <td>11,6</td> </tr> <tr> <td></td> <td>permissible tolerance</td> <td></td> <td></td> <td></td> <td>0,5</td> <td></td> <td>0,6</td> <td></td> </tr> <tr> <td>d0</td> <td>core diameter</td> <td></td> <td></td> <td>2,25</td> <td>2,6</td> <td>2,9</td> <td>3,2</td> <td>3,9</td> </tr> <tr> <td></td> <td>permissible tolerance</td> <td></td> <td></td> <td>10,1±0,3</td> <td></td> <td></td> <td>10,3</td> <td></td> </tr> <tr> <td>ds</td> <td>shank diameter</td> <td></td> <td></td> <td>2,45</td> <td>2,85</td> <td>3,20</td> <td>3,55</td> <td>4,30</td> </tr> <tr> <td></td> <td>permissible tolerance</td> <td></td> <td></td> <td></td> <td></td> <td>±0,10</td> <td></td> <td></td> </tr> <tr> <td>k</td> <td>head height max.</td> <td></td> <td></td> <td>2,1</td> <td>2,4</td> <td>2,7</td> <td>2,9</td> <td>3,4</td> </tr> <tr> <td>p</td> <td>thread pitch</td> <td></td> <td></td> <td>2,1</td> <td>2,4</td> <td>2,7</td> <td>3,0</td> <td>3,6</td> </tr> <tr> <td></td> <td>permissible tolerance</td> <td></td> <td></td> <td></td> <td></td> <td>+0,1 x p</td> <td></td> <td></td> </tr> <tr> <td colspan="2">T-STAR plus size</td> <td></td> <td></td> <td colspan="2">T15 / T20</td> <td colspan="2">T20</td> <td>T30</td> </tr> <tr> <td colspan="2">Cross recess size Type Z</td> <td></td> <td></td> <td colspan="4">3</td> <td>3</td> </tr> </table>				Nominal diameter				3,5	4,0	4,5	5,0	6,0	d	thread size			3,5	4,0	4,5	5,0	6,0		permissible tolerance					-0,3			dk	head diameter			7,0	8,0	8,8	9,6	11,6		permissible tolerance				0,5		0,6		d0	core diameter			2,25	2,6	2,9	3,2	3,9		permissible tolerance			10,1±0,3			10,3		ds	shank diameter			2,45	2,85	3,20	3,55	4,30		permissible tolerance					±0,10			k	head height max.			2,1	2,4	2,7	2,9	3,4	p	thread pitch			2,1	2,4	2,7	3,0	3,6		permissible tolerance					+0,1 x p			T-STAR plus size				T15 / T20		T20		T30	Cross recess size Type Z				3				3																																																																																																																																																																																																												
Nominal diameter				3,5	4,0	4,5	5,0	6,0																																																																																																																																																																																																																																																																																																																																					
d	thread size			3,5	4,0	4,5	5,0	6,0																																																																																																																																																																																																																																																																																																																																					
	permissible tolerance					-0,3																																																																																																																																																																																																																																																																																																																																							
dk	head diameter			7,0	8,0	8,8	9,6	11,6																																																																																																																																																																																																																																																																																																																																					
	permissible tolerance				0,5		0,6																																																																																																																																																																																																																																																																																																																																						
d0	core diameter			2,25	2,6	2,9	3,2	3,9																																																																																																																																																																																																																																																																																																																																					
	permissible tolerance			10,1±0,3			10,3																																																																																																																																																																																																																																																																																																																																						
ds	shank diameter			2,45	2,85	3,20	3,55	4,30																																																																																																																																																																																																																																																																																																																																					
	permissible tolerance					±0,10																																																																																																																																																																																																																																																																																																																																							
k	head height max.			2,1	2,4	2,7	2,9	3,4																																																																																																																																																																																																																																																																																																																																					
p	thread pitch			2,1	2,4	2,7	3,0	3,6																																																																																																																																																																																																																																																																																																																																					
	permissible tolerance					+0,1 x p																																																																																																																																																																																																																																																																																																																																							
T-STAR plus size				T15 / T20		T20		T30																																																																																																																																																																																																																																																																																																																																					
Cross recess size Type Z				3				3																																																																																																																																																																																																																																																																																																																																					
<table border="1"> <tr> <td colspan="2" rowspan="2">Ls</td> <td colspan="10">Standard thread lengths (full thread lgV / partial thread lgT)</td> </tr> <tr> <td>lgV</td> <td>lgT</td> <td>lgV</td> <td>lgT</td> <td>lgV</td> <td>lgT</td> <td>lgV</td> <td>lgT</td> <td>lgV</td> <td>lgT</td> </tr> <tr> <td>Nom. dim.</td> <td>min.</td> <td>max.</td> <td></td> <td></td> <td></td> <td></td> <td></td> <td></td> <td></td> <td></td> <td></td> <td></td> <td></td> </tr> <tr> <td>20</td> <td>18,5</td> <td>21,5</td> <td></td> <td>16,0</td> <td></td> <td>16,0</td> <td></td> <td></td> <td></td> <td></td> <td></td> <td></td> <td></td> </tr> <tr> <td>25</td> <td>23,5</td> <td>25,5</td> <td></td> <td>21,0</td> <td>18,0</td> <td>21,0</td> <td></td> <td>20,0</td> <td></td> <td>20,0</td> <td></td> <td></td> <td></td> </tr> <tr> <td>30</td> <td>28,5</td> <td>31,5</td> <td></td> <td>25,0</td> <td>18,0</td> <td>25,0</td> <td>18,0</td> <td>25,0</td> <td></td> <td>25,0</td> <td></td> <td>24,0</td> <td></td> </tr> <tr> <td>35</td> <td>33,5</td> <td>36,0</td> <td></td> <td>30,0</td> <td>23,0</td> <td>30,0</td> <td>23,0</td> <td>30,0</td> <td>25,0</td> <td>30,0</td> <td>25,0</td> <td>29,0</td> <td>24,0</td> </tr> <tr> <td>40</td> <td>38,5</td> <td>41,0</td> <td></td> <td>35,0</td> <td>23,0</td> <td>35,0</td> <td>23,0</td> <td>34,0</td> <td>35,0</td> <td>35,0</td> <td>27,0</td> <td>34,0</td> <td>24,0</td> </tr> <tr> <td>45</td> <td>43,5</td> <td>46,0</td> <td></td> <td>40,0</td> <td>30,0</td> <td>40,0</td> <td>30,0</td> <td>39,0</td> <td>30,0</td> <td>39,0</td> <td>30,0</td> <td>38,0</td> <td>29,0</td> </tr> <tr> <td>50</td> <td>48,5</td> <td>51,0</td> <td></td> <td>40,0</td> <td>32,0</td> <td>45,0</td> <td>32,5</td> <td>44,0</td> <td>32,5</td> <td>44,0</td> <td>32,0</td> <td>43,0</td> <td>32,0</td> </tr> <tr> <td>55</td> <td>53,5</td> <td>56,0</td> <td></td> <td></td> <td>35,0</td> <td>50,0</td> <td>35,0</td> <td>49,0</td> <td>37,0</td> <td>49,0</td> <td>37,0</td> <td>48,0</td> <td>37,0</td> </tr> <tr> <td>60</td> <td>58,5</td> <td>61,0</td> <td></td> <td></td> <td>35,0</td> <td>50,0</td> <td>35,0</td> <td>54,0</td> <td>37,0</td> <td>54,0</td> <td>37,0</td> <td>53,0</td> <td>37,0</td> </tr> <tr> <td>65</td> <td>63,5</td> <td>66,0</td> <td></td> <td></td> <td>40,0</td> <td>50,0</td> <td>37,5</td> <td>59,0</td> <td>42,0</td> <td>59,0</td> <td>41,0</td> <td>58,0</td> <td>41,0</td> </tr> <tr> <td>70</td> <td>68,5</td> <td>71,0</td> <td></td> <td></td> <td></td> <td></td> <td>50,0</td> <td>37,5</td> <td>59,0</td> <td>42,0</td> <td>61,0</td> <td>41,0</td> <td>51,0</td> </tr> <tr> <td>75</td> <td>73,5</td> <td>76,0</td> <td></td> <td></td> <td></td> <td></td> <td>50,0</td> <td>37,5</td> <td>59,0</td> <td>42,0</td> <td>61,0</td> <td>41,0</td> <td>61,0</td> </tr> <tr> <td>80</td> <td>78,5</td> <td>81,0</td> <td></td> <td></td> <td></td> <td></td> <td>50,0</td> <td>37,5</td> <td>59,0</td> <td>47,0</td> <td>61,0</td> <td>46,0</td> <td>51,0</td> </tr> <tr> <td>90</td> <td>88,5</td> <td>91,5</td> <td></td> <td></td> <td></td> <td></td> <td></td> <td></td> <td>59,0</td> <td>47,0</td> <td></td> <td>61,0</td> <td>61,0</td> </tr> <tr> <td>100</td> <td>98,5</td> <td>101,5</td> <td></td> <td></td> <td></td> <td></td> <td></td> <td></td> <td></td> <td></td> <td></td> <td>61,0</td> <td>61,0</td> </tr> <tr> <td>110</td> <td>108,5</td> <td>111,5</td> <td></td> <td></td> <td></td> <td></td> <td></td> <td></td> <td></td> <td></td> <td></td> <td>69,0*</td> <td>68,0*</td> </tr> <tr> <td>120</td> <td>118,5</td> <td>121,5</td> <td></td> <td></td> <td></td> <td></td> <td></td> <td></td> <td></td> <td></td> <td></td> <td>69,0*</td> <td>68,0*</td> </tr> <tr> <td>130</td> <td>128,0</td> <td>132,0</td> <td></td> <td></td> <td></td> <td></td> <td></td> <td></td> <td></td> <td></td> <td></td> <td></td> <td>68,0*</td> </tr> <tr> <td>140</td> <td>138,0</td> <td>142,0</td> <td></td> <td></td> <td></td> <td></td> <td></td> <td></td> <td></td> <td></td> <td></td> <td></td> <td>68,0*</td> </tr> <tr> <td>150</td> <td>148,0</td> <td>152,0</td> <td></td> <td></td> <td></td> <td></td> <td></td> <td></td> <td></td> <td></td> <td></td> <td></td> <td>68,0*</td> </tr> <tr> <td>160</td> <td>158,0</td> <td>162,0</td> <td></td> <td></td> <td></td> <td></td> <td></td> <td></td> <td></td> <td></td> <td></td> <td></td> <td>68,0*</td> </tr> </table>				Ls		Standard thread lengths (full thread lgV / partial thread lgT)										lgV	lgT	lgV	lgT	lgV	lgT	lgV	lgT	lgV	lgT	Nom. dim.	min.	max.												20	18,5	21,5		16,0		16,0								25	23,5	25,5		21,0	18,0	21,0		20,0		20,0				30	28,5	31,5		25,0	18,0	25,0	18,0	25,0		25,0		24,0		35	33,5	36,0		30,0	23,0	30,0	23,0	30,0	25,0	30,0	25,0	29,0	24,0	40	38,5	41,0		35,0	23,0	35,0	23,0	34,0	35,0	35,0	27,0	34,0	24,0	45	43,5	46,0		40,0	30,0	40,0	30,0	39,0	30,0	39,0	30,0	38,0	29,0	50	48,5	51,0		40,0	32,0	45,0	32,5	44,0	32,5	44,0	32,0	43,0	32,0	55	53,5	56,0			35,0	50,0	35,0	49,0	37,0	49,0	37,0	48,0	37,0	60	58,5	61,0			35,0	50,0	35,0	54,0	37,0	54,0	37,0	53,0	37,0	65	63,5	66,0			40,0	50,0	37,5	59,0	42,0	59,0	41,0	58,0	41,0	70	68,5	71,0					50,0	37,5	59,0	42,0	61,0	41,0	51,0	75	73,5	76,0					50,0	37,5	59,0	42,0	61,0	41,0	61,0	80	78,5	81,0					50,0	37,5	59,0	47,0	61,0	46,0	51,0	90	88,5	91,5							59,0	47,0		61,0	61,0	100	98,5	101,5										61,0	61,0	110	108,5	111,5										69,0*	68,0*	120	118,5	121,5										69,0*	68,0*	130	128,0	132,0											68,0*	140	138,0	142,0											68,0*	150	148,0	152,0											68,0*	160	158,0	162,0											68,0*
Ls		Standard thread lengths (full thread lgV / partial thread lgT)																																																																																																																																																																																																																																																																																																																																											
		lgV	lgT	lgV	lgT	lgV	lgT	lgV	lgT	lgV	lgT																																																																																																																																																																																																																																																																																																																																		
Nom. dim.	min.	max.																																																																																																																																																																																																																																																																																																																																											
20	18,5	21,5		16,0		16,0																																																																																																																																																																																																																																																																																																																																							
25	23,5	25,5		21,0	18,0	21,0		20,0		20,0																																																																																																																																																																																																																																																																																																																																			
30	28,5	31,5		25,0	18,0	25,0	18,0	25,0		25,0		24,0																																																																																																																																																																																																																																																																																																																																	
35	33,5	36,0		30,0	23,0	30,0	23,0	30,0	25,0	30,0	25,0	29,0	24,0																																																																																																																																																																																																																																																																																																																																
40	38,5	41,0		35,0	23,0	35,0	23,0	34,0	35,0	35,0	27,0	34,0	24,0																																																																																																																																																																																																																																																																																																																																
45	43,5	46,0		40,0	30,0	40,0	30,0	39,0	30,0	39,0	30,0	38,0	29,0																																																																																																																																																																																																																																																																																																																																
50	48,5	51,0		40,0	32,0	45,0	32,5	44,0	32,5	44,0	32,0	43,0	32,0																																																																																																																																																																																																																																																																																																																																
55	53,5	56,0			35,0	50,0	35,0	49,0	37,0	49,0	37,0	48,0	37,0																																																																																																																																																																																																																																																																																																																																
60	58,5	61,0			35,0	50,0	35,0	54,0	37,0	54,0	37,0	53,0	37,0																																																																																																																																																																																																																																																																																																																																
65	63,5	66,0			40,0	50,0	37,5	59,0	42,0	59,0	41,0	58,0	41,0																																																																																																																																																																																																																																																																																																																																
70	68,5	71,0					50,0	37,5	59,0	42,0	61,0	41,0	51,0																																																																																																																																																																																																																																																																																																																																
75	73,5	76,0					50,0	37,5	59,0	42,0	61,0	41,0	61,0																																																																																																																																																																																																																																																																																																																																
80	78,5	81,0					50,0	37,5	59,0	47,0	61,0	46,0	51,0																																																																																																																																																																																																																																																																																																																																
90	88,5	91,5							59,0	47,0		61,0	61,0																																																																																																																																																																																																																																																																																																																																
100	98,5	101,5										61,0	61,0																																																																																																																																																																																																																																																																																																																																
110	108,5	111,5										69,0*	68,0*																																																																																																																																																																																																																																																																																																																																
120	118,5	121,5										69,0*	68,0*																																																																																																																																																																																																																																																																																																																																
130	128,0	132,0											68,0*																																																																																																																																																																																																																																																																																																																																
140	138,0	142,0											68,0*																																																																																																																																																																																																																																																																																																																																
150	148,0	152,0											68,0*																																																																																																																																																																																																																																																																																																																																
160	158,0	162,0											68,0*																																																																																																																																																																																																																																																																																																																																
Screws of Ø6,0 mm: with partial thread additionally in lengths of 180 to 300 mm, in steps of 20 mm. LgT = 68,0 mm* Intermediate lengths on Ls possible																																																																																																																																																																																																																																																																																																																																													
Other thread lengths in the range > 4xdl1 to max. standard length permitted * Design C with 'lgT' = max. 65,0 mm																																																																																																																																																																																																																																																																																																																																													
Annex A19																																																																																																																																																																																																																																																																																																																																													

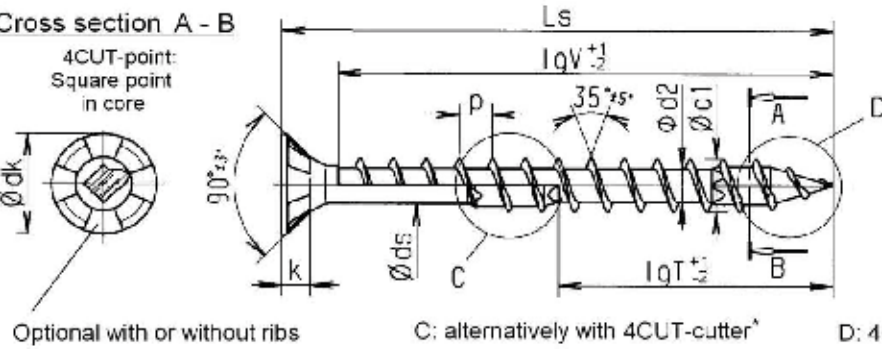
		 Washer head		Self-tapping screw with full and partial thread										
				Material: cold rolled wire according to SPAX Factory Standard Screws of high carbon steel										
Cross section A-B 4CUT-point: square point in core								Manufacturer's trade mark "SPAX"						
		C: alternatively with 4CUT-cutter*						D: 4CUT-point						
Nominal diameter				3,5		4,0		4,5		5,0		6,0		
c1	thread size			3,5		4,0		4,5		5,0		6,0		
	perm.missible tolerance							±0,5						
dk	head diameter			8,6		9,5		10,6		11,5		13,6		
	perm.missible tolerance					±0,6						±0,65		
dk1	countersink diameter			4,9		5,0		5,4		5,9		5,9		
	perm.missible tolerance							±0,20						
d2	core diameter			2,25		2,5		2,9		3,2		3,9		
	perm.missible tolerance			±0,1-0,3				±0,3						
ds	shank diameter			2,45		2,85		3,2		3,55		4,3		
	perm.missible tolerance							±0,10						
k	head height, max.			1,5		1,9		2,0		2,2		3,1		
p	thread pitch			2,1		2,4		2,7		3,0		3,5		
	perm.missible tolerance							±0,1 x p						
T-STAR plus size				115 / 120				120				130		
Cross recess size Type Z								2						
Ls		Standard thread lengths (full thread lgV / partial thread lgT)												
Nom. dim.	min	max			lgV	lgT	lgV	lgT	lgV	lgT	lgV	lgT	lgV	lgT
16	16,0	17,5			15,0									
20	18,5	20,5			18,0		18,0							
25	23,5	25,5			23,0	18,0	23,0		22,5		22,0			
30	28,5	30,5			37,0	18,0	27,5	18,0	27,5		27,0		27,0	
35	33,5	36,0			32,0	23,0	32,5	23,0	32,5	25,0	32,0	25,0	32,0	24,0
40	38,5	41,0			37,0	25,0	37,5	23,0	37,0	25,0	37,0	27,0	37,0	24,0
45	43,5	46,0			40,0	30,0	42,5	30,0	42,0	30,0	41,0	30,0	41,0	29,0
50	48,5	51,0			40,0	32,0	47,5	32,5	47,0	32,5	46,0	32,0	46,0	32,0
55	53,5	56,0				35,0	50,0	35,0	52,0	37,0	51,0	37,0	51,0	37,0
60	58,5	61,0				35,0	50,0	35,0	57,0	37,0	55,0	37,0	56,0	37,0
65	63,5	66,0				40,0	50,0	37,5	59,0	42,0	61,0	41,0	61,0	41,0
70	68,5	71,0					50,0	37,5	56,0	42,0	61,0	41,0	61,0	41,0
75	73,5	76,0					50,0	37,5	59,0	42,0	61,0	41,0	61,0	41,0
80	78,5	81,0							56,0	47,0	61,0	46,0	61,0	46,0
90	88,5	91,5							59,0	47,0		61,0		61,0
100	98,5	101,5										61,0		61,0
110	108,5	111,5										69,0*		68,0*
120	118,5	121,5										69,0*		68,0*
130	128,0	132,0												68,0*
140	138,0	142,0												68,0*
150	148,0	152,0												68,0*
160	158,0	162,0												68,0*
Screws of Ø6,0 mm with partial thread additionally in lengths of 180 to 500 mm, in steps of 20 mm, lgT= 68,0 mm*						Other thread lengths in the range 24xdl to max. standard length permitted.								
Intermediate lengths on Ls possible						* Design C with lgT = max. 65,0 mm								

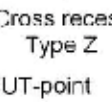
	 Raised countersunk head	Self-tapping screw with full and partial thread Material: cold rolled wire according to SPAX - Factory Standard Screws of high carbon steel						
								
Nominal diameter			3,5	4,0	4,5	5,0	6,0	
d1	thread size		3,5	4,0	4,5	5,0	6,0	
	permissible tolerance				$\pm 0,3$			
dk	head diameter		7,0	8,0	8,8	9,7	11,6	
	permissible tolerance		$\pm 0,5$			$\pm 0,6$		
d2	core diameter		2,25	2,6	2,9	3,2	3,9	
	permissible tolerance		$-0,1$ - $-0,3$			$\pm 0,3$		
ds	shank diameter		2,45	2,85	3,2	3,55	4,3	
	permissible tolerance				$\pm 0,10$			
k	head height max.		2,1	2,4	2,7	2,9	3,4	
p	thread pitch		2,1	2,4	2,7	3,0	3,5	
	permissible tolerance				$\pm 0,1$ s.p.			
T-STAR plus size			T15 / T20		T20		T30	
Cross recess size Type Z					2		3	
Ls		Standard thread lengths (full thread = lgV / partial thread = lgT)						
Nom. dim.	min	max	lgV	lgT	lgV	lgT	lgV	lgT
20	18,5	20,5	16,0		16,0			
25	23,5	25,5	21,0	18,0	21,0		20,0	20,0
30	28,5	30,5	25,0	18,0	25,0	18,0	25,0	24,0
35	33,5	36,0	30,0	23,0	30,0	23,0	30,0	25,0
40	38,5	41,0	35,0	23,0	35,0	23,0	34,0	25,0
45	43,5	46,0	40,0	30,0	40,0	30,0	39,0	30,0
50	48,5	51,0	40,0	32,0	45,0	32,5	44,0	32,5
55	53,5	56,0		35,0	50,0	35,0	49,0	37,0
60	58,5	61,0		35,0	50,0	35,0	54,0	37,0
65	63,5	66,0		40,0	50,0	37,5	59,0	42,0
70	68,5	71,0			50,0	37,5	59,0	42,0
75	73,5	76,0			50,0	37,5	59,0	42,0
80	78,5	81,0			50,0	37,5	59,0	47,0
90	88,5	91,5					59,0	47,0
100	98,5	101,5					61,0	41,0
110	108,5	111,5					61,0	41,0
120	118,5	121,5					69,0*	58,0*
130	128,0	132,0					69,0*	58,0*
140	138,0	142,0						68,0*
150	148,0	152,0						68,0*
160	158,0	162,0						68,0*
Screws of Ø6,0 mm with partial thread additionally in lengths of 78,0 to 300 mm, in steps of 20 mm, lgT = 58,0 mm*			Other thread lengths in the range 14x0,1 to max. standard length permitted.					
Intermediate lengths or Ls possible			* Design C with lgT = max. 65,0 mm					
Annex A21								

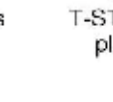
 SPAX® Pan head		Self-tapping screw with full and partial thread											
		Material: cold-rolled wire according to SPAX - Factory Standard Screws of high carbon steel											
Cross section A - B 4CUT-point: Square point in core										Manufacturer's trade mark "SPAX" 			
		C: alternatively with 4CUT-cutter* D: 4CUT-point								Cross recess Type Z 		T-STAR plus 	
Nominal diameter				3,5		4,0		4,5		5,0		6,0	
e1	thread size			3,5		4,0		4,5		5,0		6,0	
	permissible tolerance							±0,3					
ek	head diameter			7,0		8,0		9,0		9,9		11,9	
	permissible tolerance			±0,5						±0,6			
e2	core diameter			2,25		2,6		2,9		3,2		3,9	
	permissible tolerance			±0,14/0,3				±0,3					
es	shank diameter			2,45		2,85		3,2		3,55		4,3	
	permissible tolerance							±0,16					
k	head height max.			2,7		2,8		3,1		3,4		4,0	
p	thread pitch			2,1		2,4		2,7		3,0		3,6	
	permissible tolerance							±0,1 x p					
T-STAR plus size				T15 / T20				T20				T30	
Cross recess size Z								Z				Z	
Ls		Standard thread lengths (full thread = lgV / partial thread = lgT)											
Nom.	in mm	min	max	lgV	lgT	lgV	lgT	lgV	lgT	lgV	lgT	lgV	lgT
16	16,0	17,5		15,0									
20	18,5	20,5		18,0		18,0							
25	23,5	25,5		23,0	18,0	23,0		23,5		22,0			
30	28,5	30,5		27,0	18,0	27,5	18,0	27,0		27,0		27,0	
35	33,5	36,0		32,0	23,0	32,5	23,0	32,5	25,0	32,0	25,0	32,0	24,0
40	38,5	41,0		37,0	23,0	37,5	23,0	37,0	25,0	37,0	27,0	37,0	34,0
45	43,5	46,0		40,0	30,0	42,5	30,0	42,0	30,0	41,0	30,0	41,0	29,0
50	48,5	51,0		40,0	32,0	47,5	32,5	47,0	32,5	46,0	32,0	46,0	32,0
55	53,5	56,0			35,0	50,0	35,0	52,0	37,0	51,0	37,0	51,0	37,0
60	58,5	61,0			35,0	50,0	35,0	57,0	37,0	56,0	37,0	56,0	37,0
65	63,5	66,0			40,0	50,0	37,5	59,0	42,0	61,0	41,0	61,0	41,0
70	68,5	71,0				50,0	37,5	59,0	42,0	61,0	41,0	61,0	41,0
75	73,5	76,0				50,0	37,5	59,0	42,0	61,0	41,0	61,0	41,0
80	78,5	81,0				50,0	37,5	59,0	47,0	61,0	46,0	61,0	46,0
90	88,5	91,5						59,0	47,0	61,0		61,0	
100	98,5	101,5								61,0		61,0	
110	108,5	111,5								69,0*		68,0*	
120	118,5	121,5								69,0*		68,0*	
130	128,0	132,0										68,0*	
140	138,0	142,0										68,0*	
150	148,0	152,0										68,0*	
160	158,0	162,0										68,0*	
Screws of Ø5,0 mm with partial thread additionally in lengths in 180 to 300 mm, in steps of 20 mm; lgT = 68,0 mm*				Other thread lengths in the range >4xØ1 to max. standard length permitted									
Intermediate lengths on Ls possible				* Design C with lgT = max. 65,0 mm									

 SPAX [®] flat countersunk head		Self-tapping screw with full and partial thread											
		Material: cold rolled wire according to SPAX - Factory Standard. Stainless steel screws											
Cross section A - B 4CUT-point Square point in core 		Manufacturer's trade mark "SPAX" 		Cross recess Type Z 		T-STAR plus 		D: 4CUT-point 		C: alternatively with 4CUT-cutter ¹		Optional with or without ribs	
Nominal diameter				3.5		4.0		4.5		5.0		6.0	
d1	thread size			3.5		4.0		4.5		5.0		6.0	
	permissible tolerance							±0.3					
dk	head diameter			7.0		8.0		8.8		9.7		10.6	
	permissible tolerance			0.5						0.5			
d2	core diameter			2.5		2.8		3.1		3.4		3.9	
	permissible tolerance							±0.3					
ds	shank diameter			2.6		3.0		3.3		3.75		4.3	
	permissible tolerance							0.10					
k	head height max			2.1		2.4		2.7		2.9		3.4	
p	thread pitch			2.1		2.4		2.7		3.0		3.6	
	permissible tolerance							0.1 x p					
T-STAR plus size				T15 / T20				T20				T30	
Cross recess size Type Z								2				3	
lg		Standard thread lengths (full thread = lgV / partial thread = lgT)											
Nom. dim.	min	max		lgV	lgT	lgV	lgT	lgV	lgT	lgV	lgT	lgV	lgT
20	18.5	20.5		16.0		16.0							
25	23.5	25.5		21.0	18.0	21.0		20.0		20.0			
30	28.5	30.5		25.0	18.0	25.0	18.0	25.0		25.0		24.0	
35	33.5	36.0		30.0	23.0	30.0	23.0	30.0	25.0	30.0	25.0	29.0	
40	38.5	41.0		35.0	23.0	35.0	23.0	34.0	25.0	35.0	27.0	34.0	24.0
45	43.5	46.0		40.0	30.0	40.0	30.0	39.0	30.0	39.0	30.0	35.0	29.0
50	48.5	51.0		40.0	32.0	45.0	32.5	44.0	32.5	44.0	32.0	43.0	32.0
55	53.5	56.0			35.0	50.0	35.0	49.0	37.0	49.0	37.0	48.0	37.0
60	58.5	61.0			35.0	50.0	35.0	54.0	37.0	54.0	37.0	53.0	37.0
65	63.5	66.0			40.0	50.0	37.5	59.0	42.0	59.0	41.0	58.0	41.0
70	68.5	71.0				50.0	37.5	59.0	42.0	61.0	41.0	61.0	41.0
75	73.5	76.0				50.0	37.5	59	42.0	61.0	41.0	61.0	41.0
80	78.5	81.0				50.0	37.5	59.0	47.0	61.0	46.0	61.0	46.0
90	88.5	91.5						59.0	47.0	61.0		61.0	
100	98.5	101.5								61.0		61.0	
110	108.5	111.5								69.0*		68.0*	
120	118.5	121.5								69.0*		68.0*	
130	128.0	132.0										68.0*	
140	138.0	142.0										68.0*	
150	148.0	152.0										68.0*	
160	158.0	162.0										68.0*	
Intermediate lengths on Ls possible						Other thread lengths in the range ±4sd1 to max. standard length permitted.							
						* Design C with lg ¹ = max. 55.0 mm							
Annex A23													

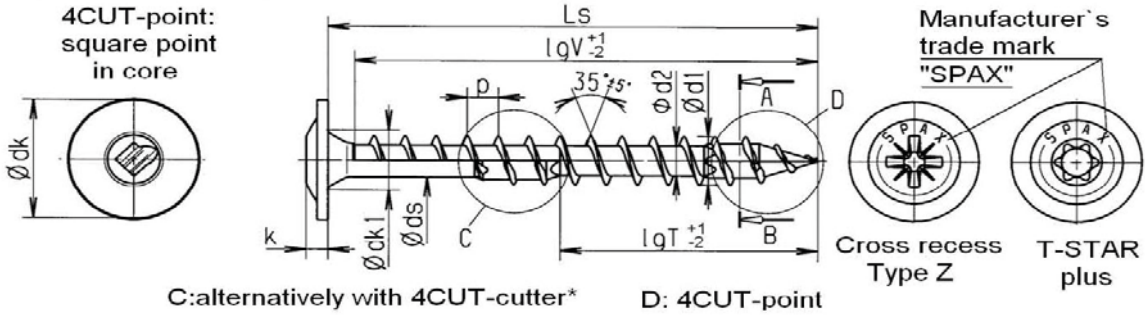
	 SPAX [®] Washer head	Self-tapping screw with full and partial thread Material: cold rolled wire according to SPAX - Factory Standard Stainless steel screws												
<p>Cross section A-B 4CUT-point: square point in core</p>  <p>C: alternatively with 4CUT-cutter* D: 4CUT-point</p>														
Nominal diameter			3,5	4,0	4,5	5,0	6,0							
d1	thread size		3,5	4,0	4,5	5,1	6,1							
	permissible tolerance				±0,3									
dk	head diameter		8,6	9,6	10,6	11,6	13,6							
	permissible tolerance				±0,6		±0,65							
dk1	countersink diameter		4,9	5,0	5,4	5,9	6,9							
	permissible tolerance				+0,20									
d2	core diameter		2,5	2,8	3,1	3,4	3,9							
	permissible tolerance				±0,3									
ds	shank diameter		2,6	3,0	3,3	3,75	4,3							
	permissible tolerance				±0,10									
k	head height max.		1,8	1,9	2,0	2,2	3,1							
p	thread pitch		2,1	2,4	2,7	3,0	3,6							
	permissible tolerance				±0,1 x p									
T-STAR plus size			T15 / T20		T20		T30							
Cross recess size Type Z			2											
Ls		Standard thread lengths (full thread = lgV / partial thread = lgT)												
Nom. dim.	min	max												
16	16,0	17,5			15,0									
20	18,5	20,5			18,0		18,0							
25	23,5	25,5			23,0	18,0	23,0		22,5		22,0			
30	28,5	30,5			27,0	18,0	27,5	18,0	27,5		27,0		27,0	
35	33,5	36,0			32,0	23,0	32,5	23,0	32,5	25,0	32,0	25,0	32,0	24,0
40	38,5	41,0			37,0	23,0	37,5	23,0	37,0	25,0	37,0	27,0	37,0	24,0
45	43,5	46,0			40,0	30,0	42,5	30,0	42,0	30,0	41,0	30,0	41,0	29,0
50	48,5	51,0			40,0	32,0	47,5	32,5	47,0	32,5	46,0	32,0	46,0	32,0
55	53,5	56,0				35,0	50,0	35,0	52,0	37,0	51,0	37,0	51,0	37,0
60	58,5	61,0				35,0	50,0	35,0	57,0	37,0	56,0	37,0	56,0	37,0
65	63,5	66,0				40,0	50,0	37,5	59,0	42,0	61,0	41,0	61,0	41,0
70	68,5	71,0					50,0	37,5	59,0	42,0	61,0	41,0	61,0	41,0
75	73,5	76,0					50,0	37,5	59,0	42,0	61,0	41,0	61,0	41,0
80	78,5	81,0							59,0	47,0	61,0	46,0	61,0	46,0
90	88,5	91,5							59,0	47,0		61,0		61,0
100	98,5	101,5										61,0		61,0
110	108,5	111,5										69,0*		68,0*
120	118,5	121,5										69,0*		68,0*
130	128,0	132,0												68,0*
140	138,0	142,0												68,0*
150	148,0	152,0												68,0*
160	158,0	162,0												68,0*
Intermediate lengths on Ls possible				Other thread lengths in the range ≥4xdl to max. standard length permitted. * Design C with lgT= max. 65,0 mm										
Annex A24														

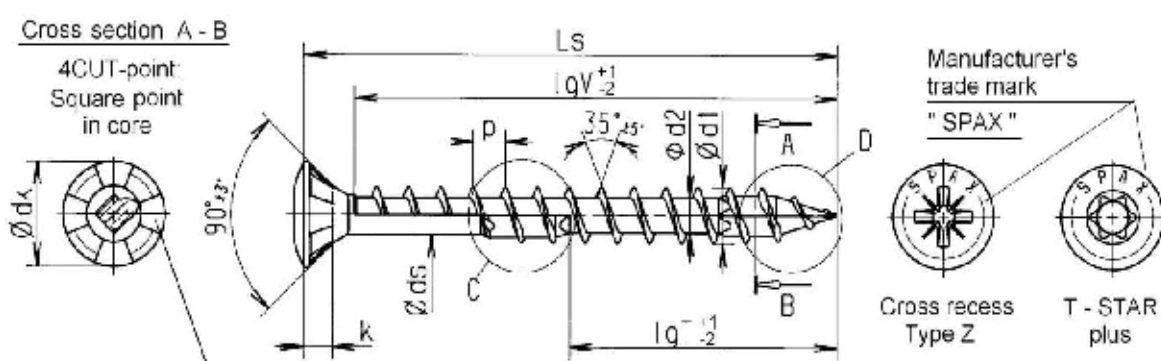
 SPAX [®] Raised countersunk head		Self-tapping screw with full and partial thread Material: cold rolled wire according to SPAX - Factory Standard Stainless steel screws													
		Cross section A - B 4CUT-point Square point in core													
		Manufacturer's trade mark "SPAX" Cross recess Type Z T-STAR plus Optional with or without ribs C: alternatively with 4CUT-cutter* D: 4CUT-point													
Nominal diameter				3,5		4,0		4,5		5,0		6,0			
d1	thread size			3,5		4,0		4,5		5,1		5,1			
	permissible tolerance							+0,3							
dk	head diameter			7,0		8,0		8,8		9,7		11,5			
	permissible tolerance			±0,5						±0,6					
d2	core diameter			2,5		2,8		3,1		3,4		3,9			
	permissible tolerance							±0,3							
ds	shank diameter			3,6		3,0		3,3		3,75		4,3			
	permissible tolerance							±0,10							
k	head height max.			3,1		2,4		2,7		2,9		3,4			
p	thread pitch			2,1		2,1		2,7		3,0		3,6			
	permissible tolerance							±0,1 x p							
T-STAR plus size				T15 / T20				T30				T30			
Cross recess size Type Z								2				3			
s		Standard thread lengths (full thread = lgV / partial thread = lgT)													
Nom. in	min	max				lgV	lgT	lgV	lgT	lgV	lgT	lgV	lgT	lgV	lgT
20	18,5	20,5				16,0	16,0	16,0							
25	23,5	25,5				21,0	18,0	21,0		20,0		20,0			
30	28,5	30,5				25,0	18,0	25,0	18,0	25,0	25,0	25,0	24,0		
35	33,5	36,0				30,0	23,0	30,0	23,0	30,0	25,0	30,0	25,0	29,0	
40	38,5	41,0				35,0	23,0	35,0	23,0	34,0	25,0	35,0	27,0	34,0	24,0
45	43,5	46,0				30,0	40,0	30,0	39,0	30,0	39,0	30,0	38,0	29,0	
50	48,5	51,0				32,0	45,0	32,5	44,0	32,5	44,0	32,0	43,0	32,0	
55	53,5	56,0				35,0	50,0	35,0	49,0	37,0	49,0	37,0	48,0	37,0	
60	58,5	61,0				35,0	50,0	35,0	54,0	37,0	54,0	37,0	53,0	37,0	
65	63,5	66,0				40,0	50,0	37,5	59,0	42,0	59,0	41,0	58,0	41,0	
70	68,5	71,0						50,0	37,5	59,0	42,0	61,0	41,0	61,0	41,0
75	73,5	76,0						50,0	37,5	59,0	42,0	61,0	41,0	61,0	41,0
80	78,5	81,0						50,0	37,5	59,0	47,0	61,0	46,0	61,0	46,0
90	88,5	91,5								59,0	47,0		61,0		61,0
100	98,5	101,5										61,0		61,0	
110	108,5	111,5										69,0*		68,0*	
120	118,5	121,5										69,0*		68,0*	
130	128,0	132,0												68,0*	
140	138,0	142,0												68,0*	
150	148,0	152,0												68,0*	
160	158,0	162,0												68,0*	
Intermediate lengths on Ls possible						Other thread lengths in the range >4xdl to max. standard length permitted									
						* Design C with lgT = max. 65,0 mm									
Annex A25															

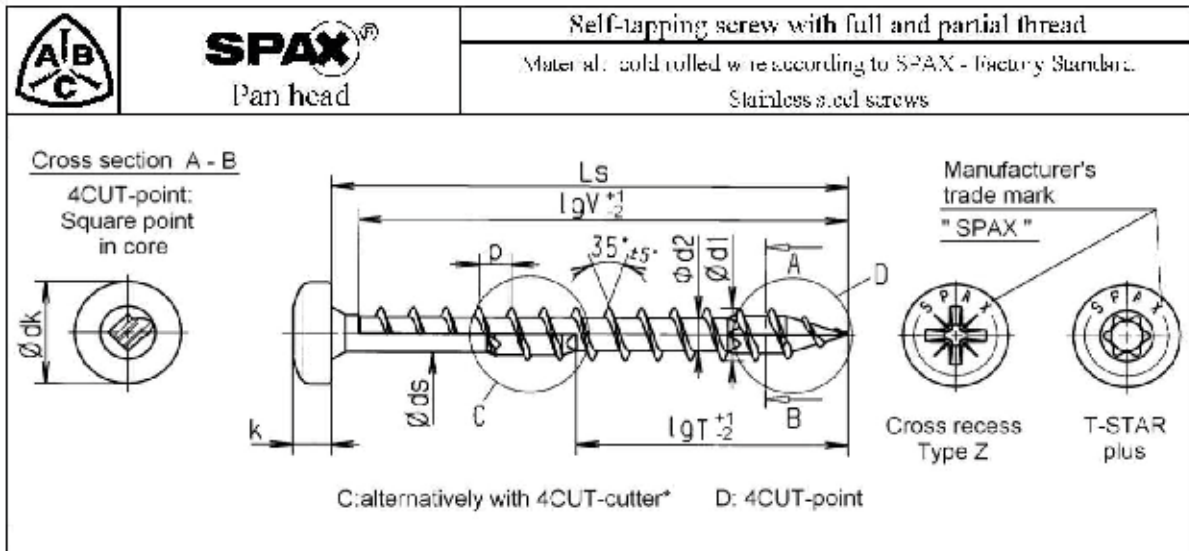

Nominal diameter		3,5	4,0	4,5	5,0	6,0
d1	thread size	3,5	4,0	4,5	5,1	6,1
	permissible tolerance			0,5		
dk	head diameter	7,0	7,9	9,0	9,9	11,9
	permissible tolerance		0,5		0,6	
d2	core diameter	3,5	3,8	3,1	3,4	3,9
	permissible tolerance			0,5		
ds	shank diameter	2,6	3,0	3,3	3,75	4,3
	permissible tolerance			0,10		
k	head height max.	2,7	2,9	3,1	3,4	4,0
p	thread pitch	3,1	2,4	2,7	3,0	3,6
	permissible tolerance			=0,1 x p		
T-STAR plus size		T15 / T20		T20		T30
Cross recess size Z		2				3





Ls	Standard thread lengths (full thread = lgV / partial thread = lgT)												
	Nom. diam.	min	max	lgV	lgT	lgV	lgT	lgV	lgT	lgV	lgT	lgV	lgT
16	16,0	17,5	15,0										
20	18,5	20,5	18,0	18,0									
25	23,5	25,5	23,0	18,0	23,0	22,5	22,0						
30	28,5	30,5	27,0	18,0	27,5	18,0	27,5	27,0					
35	33,5	36,0	32,0	24,0	32,5	24,0	32,5	25,0	32,0	25,0	32,0		
40	38,5	41,0	37,0	23,0	37,5	23,0	37,0	25,0	37,0	27,0	37,0	24,0	
45	43,5	46,0	40,0	30,0	42,5	30,0	42,0	30,0	41,0	30,0	41,0	29,0	
50	48,5	51,0	40,0	32,0	47,5	33,5	47,0	32,5	46,0	32,0	46,0	32,0	
55	53,5	56,0		35,0	50,0	35,0	52,0	37,0	51,0	37,0	51,0	37,0	
60	58,5	61,0		35,0	50,0	35,0	57,0	37,0	56,0	37,0	56,0	37,0	
65	63,5	66,0		40,0	50,0	37,5	59,0	42,0	61,0	41,0	61,0	41,0	
70	68,5	71,0			50,0	37,5	59,0	42,0	61,0	41,0	61,0	41,0	
75	73,5	76,0			50,0	37,5	59,0	42,0	61,0	41,0	61,0	41,0	
80	78,5	81,0			50,0	37,5	59,0	47,0	61,0	46,0	61,0	46,0	
90	88,5	91,5					59,0	47,0		61,0	46,0	61,0	
100	98,5	101,5								61,0		61,0	
110	108,5	111,5								69,0*		68,0*	
120	118,5	121,5								69,0*		68,0*	
130	128,0	132,0										68,0*	
140	138,0	142,0										68,0*	
150	148,0	152,0										68,0*	
160	158,0	162,0										68,0*	

Intermediate lengths or Ls possible

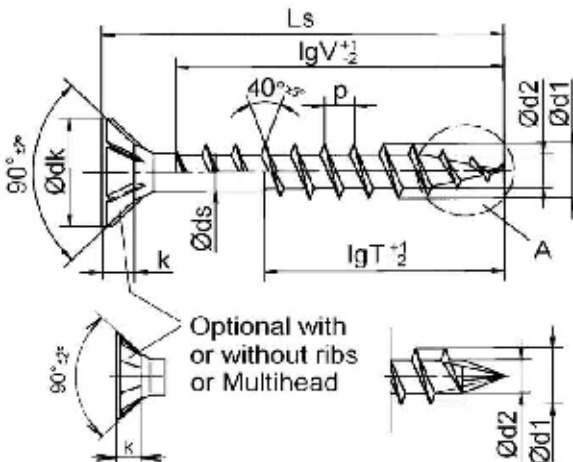

Other thread lengths in the range possible to max. standard length permitted.

* Design C with lgT max. 55,0 mm

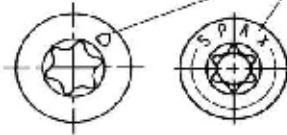
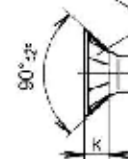
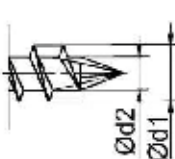

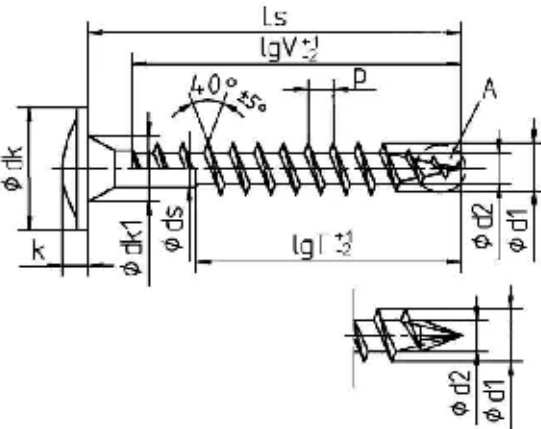
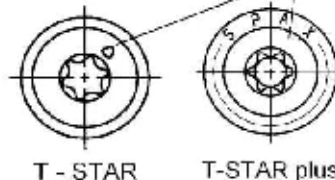
Annex A26

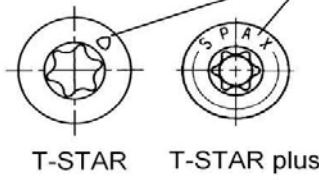
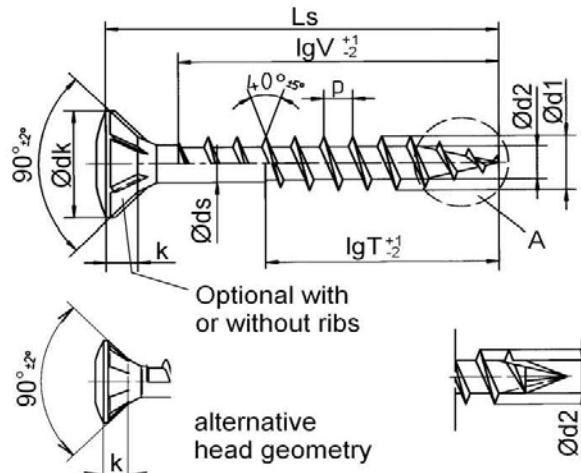
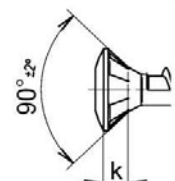
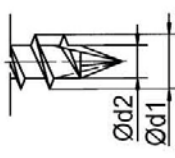
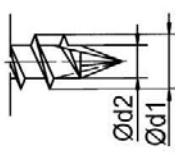

			Self-tapping screw with full and partial thread Material: cold rolled wire according to SPAX - Factory standard Screws of high carbon steel			
	Flat countersunk head					
			Manufacturer's trade mark  or "SPAX"  T-STAR T-STAR plus A: alternatively with CUT-point			
 Optional with or without ribs or Multihead						
 A: alternatively with CUT-point						
Nominal diameter			8,0	10,0	12,0	
d1	thread size		8,1	10,0	12,0	
	permissible tolerance		+0,4	0,5	+0,6	
dk	head diameter		15,7	18,6	22,6	
	permissible tolerance		+0,75	0,9	+1,1	
d2	core diameter		5,0	6,1	7,35	
	permissible tolerance		±0,3		±0,35	
ds	shank diameter		5,7	6,8	8,5	
	permissible tolerance			±0,25		
k	head height max.		≤4	6,0	6,6	
p	thread pitch		≤0	5,0	6,3	
	permissible tolerance			+0,1 x p		
T-STAR	size		T40	T50	T50	
Ls			Standard thread lengths (full thread - lgV / partial thread - lgT)			
Nom. dim.	min	max	lgV	lgT	lgV	lgT
40	38,5	41,5	32,0			
45	43,5	46,5	37,0			
50	48,5	51,5	42,0	32,0	40,0	
55	53,5	56,5	47,0	32,0	45,0	
60	58,5	61,5	52,0	37,0	50,0	
65	63,5	66,5	57,0	37,0	55,0	40,0
70	68,5	71,5	61,0	42,0	60,0	40,0
75	73,5	76,5	61,0	42,0	60,0	45,0
80	78,5	81,5	70,0	47,0	70,0	50,0
90	88,5	91,5	80,0	52,0	80,0	55,0
100	98,5	101,5	80,0	57,0	80,0	60,0
110	108,5	111,5	80,0	70,0	80,0	70,0
120	118,5	121,5	80,0	70,0	80,0	70,0
130	128,0	132,0	80,0	70,0	80,0	70,0
140	138,0	142,0		80,0		80,0
150	148,0	152,0		80,0		80,0
160	158,0	162,0		80,0		100,0
180	178,0	182,0		80,0		100,0
200	198,0	202,0		80,0		100,0
to						
600	597,0	602,0		80,0		100,0
Intermediate lengths on Ls possible			Other thread lengths in the range ≥4xd1 to max. standard length permitted.			
Annex A27						

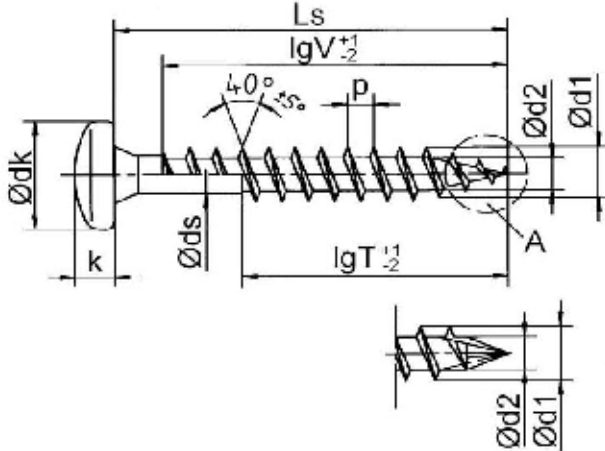
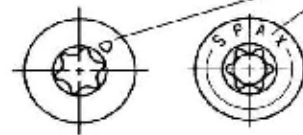
 SPAX[®]-S Washer head		Self-tapping screw with full and partial thread				
		Material: cold rolled wire according to SPAX - Factory standard Screws of high carbon steel				
		Manufacturer's trade mark Δ or "SPAX"  T - STAR T-STAR plus A: alternatively with CUT-point				
Nominal diameter		8,0	10,0	12,0		
d1	thread size	8,1	10,0	12,0		
	permissible tolerance	+0,4	+0,5	+0,6		
dk	head diameter	8,0	10,0	12,0		
	permissible tolerance	0,9	1,0	1,1		
dk1	countersink diameter	9,0	12,0	14,0		
	permissible tolerance	+0,30				
d2	core diameter	5,0	6,1	7,35		
	permissible tolerance	-0,3				
ds	shank diameter	5,7	6,8	8,5		
	permissible tolerance	+0,25				
k	head height max.	4,0	4,7	5,6		
p	thread pitch	4,0	5,0	6,0		
	permissible tolerance	+0,1 x p				
T - STAR Δ size		P40		P50		
Ls	Standard thread lengths (full thread = lgV / partial thread = lgT)					
Nom. dim.	min	max	lgV	lgT	lgV	lgT
40	38,5	41,5	37,0			
45	43,5	46,5	42,0			
50	48,5	51,5	46,0	50,0		
55	53,5	56,5	51,0	55,0	50,0	50,0
60	58,5	61,5	56,0	57,0	55,0	55,0
65	63,5	66,5	61,0	67,0	60,0	60,0
70	68,5	71,5	61,0	62,0	60,0	60,0
75	73,5	76,5	70,0	62,0	70,0	65,0
80	78,5	81,5	70,0	67,0	70,0	50,0
90	88,5	91,5	80,0	52,0	80,0	55,0
100	98,5	101,5	80,0	57,0	80,0	60,0
110	108,5	111,5	80,0	70,0	80,0	80,0
120	118,5	121,5	80,0	70,0	80,0	80,0
130	128,0	132,0	80,0	70,0	80,0	80,0
140	138,0	142,0		80,0		80,0
150	148,0	152,0		80,0		100,0
160	158,0	162,0		80,0		100,0
180	178,0	182,0		80,0		100,0
200	198,0	202,0		80,0		100,0
to						
600	597,0	602,0		80,0		100,0
Intermediate lengths on Ls possible			Other thread lengths in the range fixed to max. standard length permitted			
Annex A2S						

		SPAX®-S Raised countersunk head		Self-tapping screw with full and partial thread Material: cold rolled wire according to SPAX - Factory standard Screws of high carbon steel							
				Manufacturer's trade mark  or "SPAX" 							
		Optional with or without ribs 		alternative head geometry 		A: alternatively with CUT-point 					
Nominal diameter		8,0		10,0		12,0					
d1	thread size	8,1		10,0		12,0					
	permissible tolerance	±0,4		±0,5		±0,6					
dk	head diameter	15,1		18,6		22,6					
	permissible tolerance	±0,75		±0,9		±1,1					
d2	core diameter	5,0		6,1		7,35					
	permissible tolerance	±0,3		±0,35							
ds	shank diameter	5,7		6,8		8,5					
	permissible tolerance			±0,25							
k	head height max.	4,4		6,0		6,6					
p	thread pitch	4,0		5,0		6,0					
	permissible tolerance			±0,1 x p							
T - STAR	size	T40		T50		T50					
Ls		Standard thread lengths (full thread=lgV / partial thread = lgT)									
Nom. dim.	min	max	lgV	lgT	lgV	lgT	lgV	lgT			
40	38,5	41,5	32,0								
45	43,5	46,5	37,0								
50	48,5	51,5	42,0	32,0	40,0						
55	53,5	56,5	47,0	32,0	45,0						
60	58,5	61,5	52,0	37,0	50,0		50,0				
65	63,5	66,5	57,0	37,0	55,0	40,0	55,0				
70	68,5	71,5	61,0	42,0	60,0	40,0	60,0				
75	73,5	76,5	61,0	42,0	60,0	45,0	60,0				
80	78,5	81,5	70,0	47,0	70,0	50,0	70,0	50,0			
90	88,5	91,5	80,0	52,0	80,0	55,0	80,0	55,0			
100	98,5	101,5	80,0	57,0	80,0	60,0	80,0	60,0			
110	108,5	111,5	80,0	70,0	80,0	70,0		80,0			
120	118,5	121,5	80,0	70,0	80,0	70,0		80,0			
130	128,0	132,0	80,0	70,0	80,0	70,0		80,0			
140	138,0	142,0		80,0		80,0		80,0			
150	148,0	152,0		80,0		80,0		100,0			
160	158,0	162,0		80,0		80,0		100,0			
180	178,0	182,0		80,0		80,0		100,0			
200	198,0	202,0		80,0		80,0		100,0			
to											
600	597,0	602,0		80,0		80,0		100,0			
Intermediate lengths on Ls possible						Other thread lengths in the range ≥4xd1 to max. standard length permitted					
Annex A29											

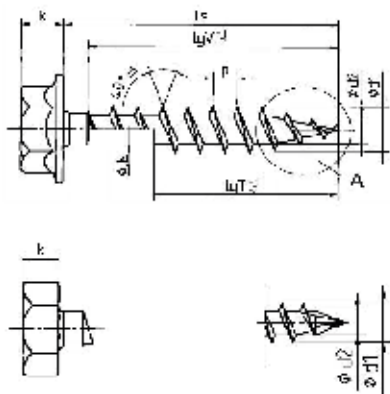
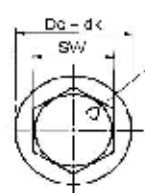
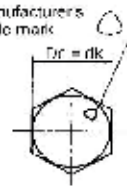
 SPAX®-S Pan head		Self-tapping screw with full and partial thread								
		Material: cold rolled wire according to SPAX - factory standard Screws of high carbon steel								
		Manufacturer's trade mark Δ or "SPAX"  T-STAR T-STAR plus A: alternatively with CUT-point								
Nominal diameter		8,0	10,0	12,0						
d1	thread size	8,1	10,0	12,0						
	permissible tolerance	+0,4	+0,5	+0,6						
dk	head diameter	15,5	19,0	23,0						
	permissible tolerance	$\pm 0,75$	$\pm 0,95$	$\pm 1,15$						
d2	core diameter	5,0	6,1	7,35						
	permissible tolerance	$\pm 0,3$		$\pm 0,35$						
ds	shank diameter	5,7	6,8	8,5						
	permissible tolerance		+0,25							
k	head height max.	5,7	7,1	8,5						
R	raised radius	16,0	20,0	24,0						
p	thread pitch	4,0	5,0	6,0						
	permissible tolerance		$\pm 0,1 \times p$							
T-STAR size		T40	T50	T50						
Ls		Standard thread lengths (full thread=lgV / partial thread = lgT)								
Nom. dim.	min	max	lgV	lgT	lgV	lgT	lgV	lgT		
40	38,0	41,5	37,0							
45	43,0	46,5	42,0							
50	48,5	51,5	45,0	32,0						
55	53,5	56,5	51,0	32,0	50,0		50,0			
60	58,5	61,5	56,0	37,0	55,0		55,0			
65	63,5	66,5	61,0	37,0	60,0	40,0	60,0			
70	68,5	71,5	61,0	42,0	60,0	40,0	60,0			
75	73,5	76,5	70,0	42,0	70,0	45,0	70,0			
80	78,5	81,5	70,0	47,0	70,0	50,0	70,0	50,0		
90	86,5	91,5	80,0	52,0	80,0	55,0	80,0	55,0		
100	98,5	101,5	80,0	57,0	80,0	60,0	80,0	60,0		
110	108,5	111,5	80,0	70,0	80,0	70,0		80,0		
120	118,5	121,5	80,0	70,0	80,0	70,0		80,0		
130	128,0	132,0	80,0	70,0	80,0	70,0		80,0		
140	138,0	142,0		80,0		80,0		80,0		
150	148,0	152,0		80,0		80,0		100,0		
160	158,0	162,0		80,0		80,0		100,0		
180	178,0	182,0		80,0		80,0		100,0		
200	198,0	202,0		80,0		80,0		100,0		
to										
600	597,0	602,0		80,0		80,0		100,0		
Intermediate lengths on Ls possible					Other thread lengths in the range $\geq 4 \times d1$ to max. standard length permitted					
Annex A50										

			Self-tapping screw with full and partial thread			
	Hex. head with/without flange		Material: cold rolled wire according to SPAX - Factory standard Screws of high carbon steel			
<div style="display: flex; justify-content: space-around; align-items: flex-start;"> <div style="text-align: center;">  </div> <div style="text-align: center;">  <p>Hex. head with flange</p> </div> <div style="text-align: center;">  <p>Hex. head without flange</p> </div> </div> <p style="text-align: center;">A: alternatively with CUT-point;</p>						
			with flange		without flange	
Nominal diameter	8,0	10,0	12,0	8,0	10,0	12,0
d1 thread size	8.1	10.0	12.0	8.1	10.0	12.0
permissible tolerance	-0.4	-0.5	-0.6	-0.4	-0.5	-0.6
SW wrench size	10	13	16	10	13	16
Dc flange diameter	17.0	20.8	24.7			
permissible tolerance	+0.85	+1.0	+1.2			
d2 core diameter	5.0	6.1	7.35	5.0	6.1	7.35
permissible tolerance	+0.3		+0.35	+0.3		+0.35
ds shank diameter	5.7	6.8	8.5	5.7	6.8	8.5
permissible tolerance	+0.25			+0.25		
k head height max.	8.5	9.7	12.1	6.0	7.0	8.0
p thread pitch	4.0	5.0	6.0	4.0	5.0	6.0
permissible tolerance	±0.1 x p			±0.1 x p		
Ls Standard thread lengths (full thread lgV / partial thread lgT)						
Nom. dim.	min	max	lgV	lgT	lgV	lgT
40	38,5	41,5	37,0			
45	43,5	46,5	42,0			
50	48,5	51,5	46,0	32,0	45,0	
55	53,5	56,5	51,0	32,0	50,0	50,0
60	58,5	61,5	56,0	37,0	55,0	55,0
65	63,5	66,5	61,0	37,0	60,0	40,0
70	68,5	71,5	61,0	42,0	60,0	40,0
75	73,5	76,5	70,0	42,0	70,0	45,0
80	78,5	81,5	70,0	47,0	70,0	50,0
90	88,5	91,5	80,0	52,0	80,0	55,0
100	98,5	101,5	80,0	57,0	80,0	60,0
110	108,5	111,5	80,0	70,0	80,0	70,0
120	118,5	121,5	80,0	70,0	80,0	70,0
130	128,0	132,0	80,0	70,0	80,0	70,0
140	138,0	142,0	80,0	80,0	80,0	80,0
150	148,0	152,0	80,0	80,0	100,0	80,0
160	158,0	162,0	80,0	80,0	100,0	80,0
180	178,0	182,0	80,0	80,0	100,0	80,0
200	198,0	202,0	80,0	80,0	100,0	80,0
to						
600	597,0	602,0	80,0	80,0	100,0	80,0
Intermediate lengths on Ls possible				Other thread lengths in the range >4x d1 to max. standard length permitted		
Annex A31						

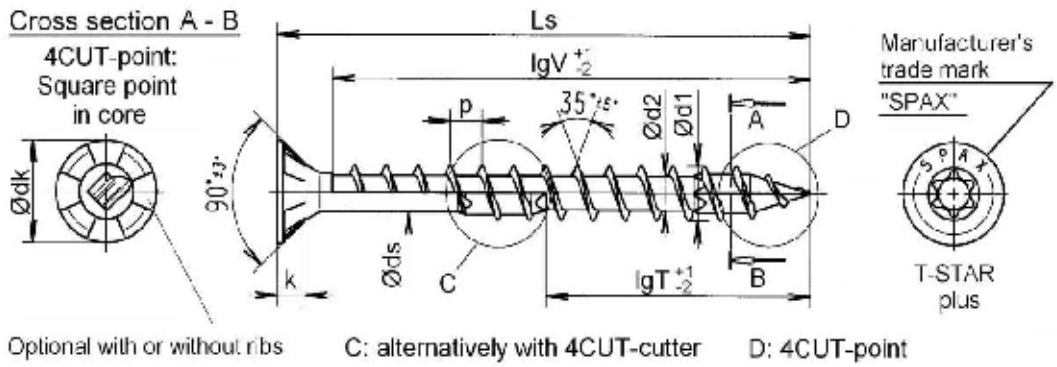

	 Flat countersunk head	Self-tapping screw with full and partial thread Material: cold rolled wire according to SPAX - Factory standard Screws of high carbon steel



Nominal diameter		8,0	10,0					
d1	thread size	8,1	10,0					
	permissible tolerance	+0,4	+0,5					
dk	head diameter	12,1	18,6					
	permissible tolerance	$\pm 0,75$	$\pm 0,9$					
d2	core diameter	5,0	6,1					
	permissible tolerance	-0,3						
ds	shank diameter	5,7	6,8					
	permissible tolerance	-0,25	+0,25					
k	head height max.	4,4	6,0					
p	thread pitch	4,8	6,0					
	permissible	$\pm 0,1 \times p$	$\pm 0,1 \times p$					
T-STAR plus size		T40	T50					

Ls			Standard thread lengths (full thread = lgV / partial thread = lgT)											
Nom. diam.	mm	max	lgV	lgT	lgV	lgT								
40	38,5	41,5	32,0											
45	43,5	46,5	37,0											
50	48,5	51,5	42,0	32,0	40,0									
55	53,5	56,5	47,0	32,0	45,0									
60	58,5	61,5	52,0	37,0	50,0									
65	63,5	66,5	57,0	37,0	55,0									
70	68,5	71,5	61,0	42,0	60,0									
75	73,5	76,5	61,0	42,0	60,0									
80	78,5	81,5	70,0	47,0	70,0	50,0								
90	88,5	91,5	80,0	52,0	80,0	55,0								
100	98,5	101,5	80,0	57,0	80,0	60,0								
110	108,5	111,5	80,0	70,0	80,0	80,0								
120	118,5	121,5	80,0	70,0	80,0	80,0								
130	128,0	132,0	80,0	70,0	80,0	80,0								
140	138,0	142,0		80,0		80,0								
150	148,0	152,0		80,0		80,0								
160	158,0	162,0		80,0		80,0								
180	178,0	182,0		80,0		80,0								
200	198,0	202,0		80,0		80,0								
to														
600	597,0	602,0		80,0		80,0								

Intermediate lengths on Ls possible Other thread lengths in the range $\geq 4 \times d1$ to max. standard length permitted

	 Washer head	Self-tapping screw with full and partial thread
		Material: cold rolled wire according to SPAX - factory standard Screws of high carbon steel

Cross section A - B

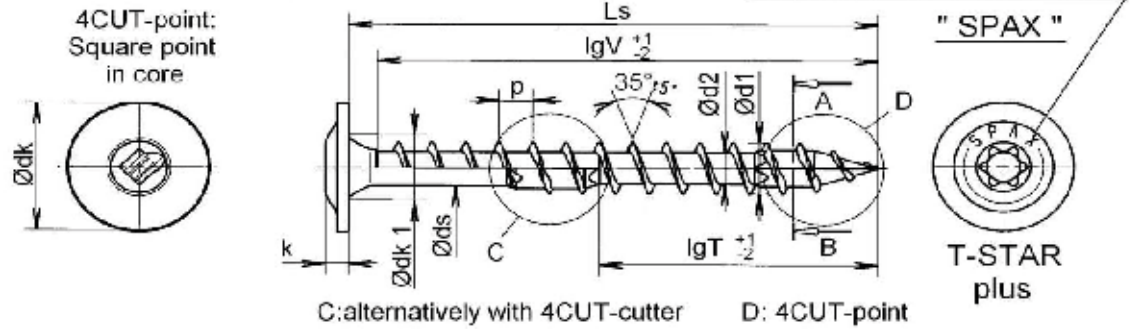



Nominal diameter		8,0				10,0		
d1	thread size	8,1				10,0		
	permissible tolerance	±0,4				±0,5		
dk	head diameter	18,0	20,0	22,0	24,0	23,0	25,0	27,0
	permissible tolerance	±0,9	±1,0	±1,1	±1,2	±1,15	±1,25	±1,35
ck1	countersink diameter	9,00				12,00		
	permissible tolerance	+0,50				+0,5		
d2	core diameter	5,0				6,1		
	permissible tolerance					+0,3		
ds	shank diameter	5,7				6,8		
	permissible tolerance	±0,25				±0,25		
k	head height max	4,3				4,7		
p	thread pitch	4,8				6,0		
	permissible tolerance	±0,1 x p				±0,1 x p		
T-STAR plus size		T40				T50		
Ls		Standard thread lengths (full thread lgV / partial thread lgT)						
Nom.	mm	min	max	lgV	lgT	lgV	lgT	
40		38,5	41,5	37,0				
45		43,5	46,5	42,0				
50		48,5	51,5	46,0	32,0	45,0		
55		53,5	56,5	51,0	32,0	50,0		
60		58,5	61,5	56,0	37,0	55,0		
65		63,5	66,5	61,0	37,0	60,0		
70		68,5	71,5	61,0	42,0	60,0		
75		73,5	76,5	70,0	42,0	70,0		
80		78,5	81,5	70,0	47,0	70,0		50,0
90		88,5	91,5	80,0	52,0	80,0		55,0
100		98,5	101,5	80,0	57,0	80,0		60,0
110		108,5	111,5	80,0	70,0	80,0		80,0
120		118,5	121,5	80,0	70,0	90,0		80,0
130		128,0	132,0	80,0	70,0	80,0		80,0
140		138,0	142,0		80,0			80,0
150		148,0	152,0		80,0			80,0
160		158,0	162,0		80,0			80,0
180		178,0	182,0		80,0			80,0
200		198,0	202,0		80,0			80,0
to								
600*		597,0	602,0		80,0			80,0

Intermediate lengths on Ls possible
 [] - Preferred size

*for d1=10,0 Ls up to 1.000 mm possible

Other thread lengths in the range 24x d1 to max. standard length permitted

	 SPAX [®] Raised countersunk head	Self-tapping screw with full and partial thread Material: cold rolled wire according to SPAX - Factory standard Screws of high carbon steel

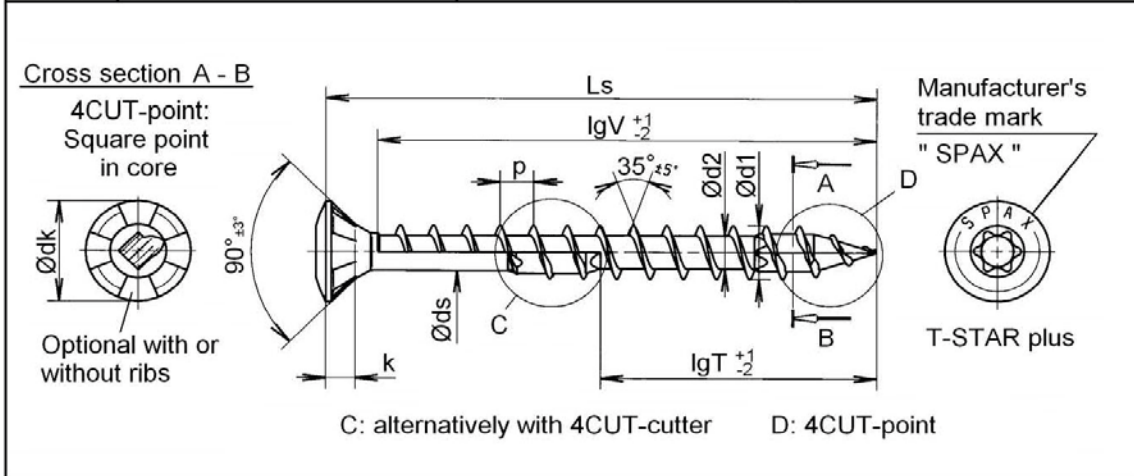





Nominal diameter		8,0	10,0				
d1	thread size	8,1	10,0				
	permissible tolerance	±0,4	±0,5				
dk	head diameter	15,1	18,6				
	permissible tolerance	±0,75	±0,9				
d2	core diameter	5,0	6,1				
	permissible tolerance	±0,3					
ds	shank diameter	5,7	6,8				
	permissible tolerance	±0,25					
k	head height max.	4,4	6,0				
p	thread pitch	4,8	6,0				
	permissible tolerance	+0,1 x p	+0,1 x p				
T-STAR plus size		T40	T50				



Ls			Standard thread lengths (full thread=lgV / partial thread = lgT)														
Nom.dim.	min	max	lgV	lgT	lgV	lgT											
40	38,5	41,5	32,0														
45	43,5	46,5	37,0														
50	48,5	51,5	42,0	32,0	40,0												
55	53,5	56,5	47,0	32,0	45,0												
60	58,5	61,5	52,0	37,0	50,0												
65	63,5	66,5	57,0	37,0	55,0												
70	68,5	71,5	61,0	42,0	60,0												
75	73,5	76,5	61,0	42,0	60,0												
80	78,5	81,5	70,0	47,0	70,0	50,0											
90	88,5	91,5	80,0	52,0	80,0	55,0											
100	98,5	101,5	80,0	57,0	80,0	60,0											
110	108,5	111,5	80,0	70,0	80,0	80,0											
120	118,5	121,5	80,0	70,0	80,0	80,0											
130	128,0	132,0	80,0	70,0	80,0	80,0											
140	138,0	142,0		80,0		80,0											
150	148,0	152,0		80,0		80,0											
160	158,0	162,0		80,0		80,0											
180	178,0	182,0		80,0		80,0											
200	198,0	202,0		80,0		80,0											
to																	
600	597,0	602,0		80,0		80,0											

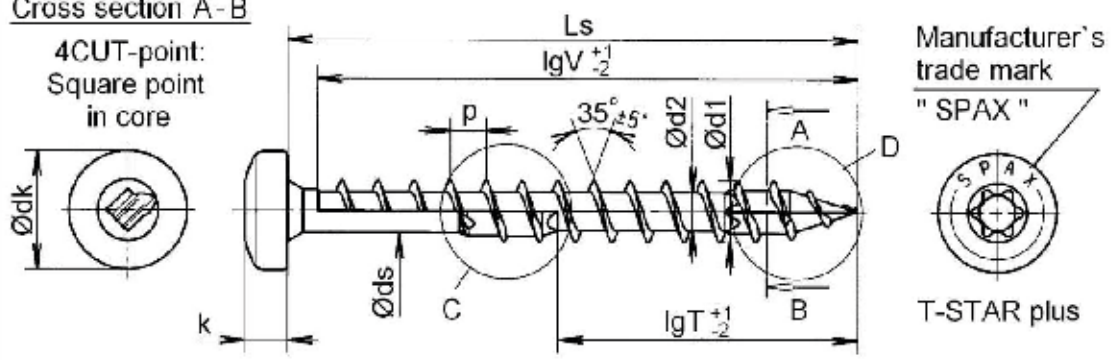

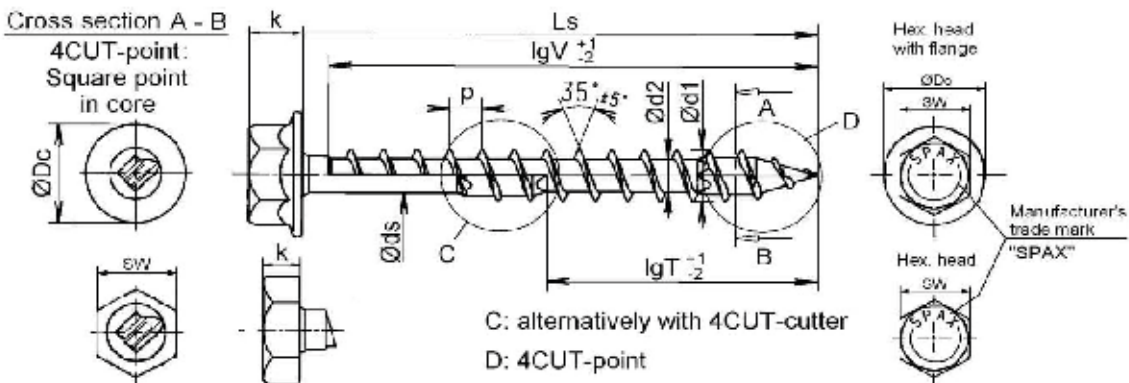

Intermediate lengths on Ls possible

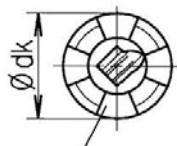
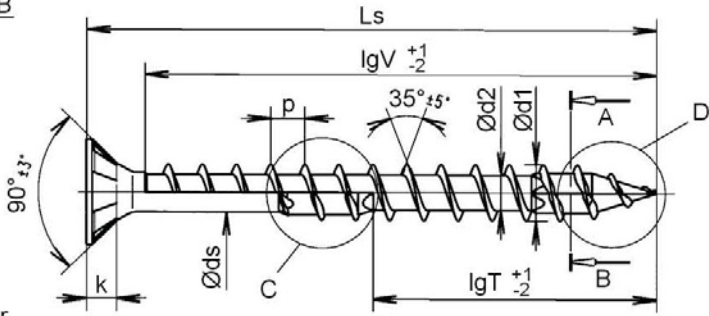
Other thread lengths in the range ≥4xd1 to max. standard length permitted



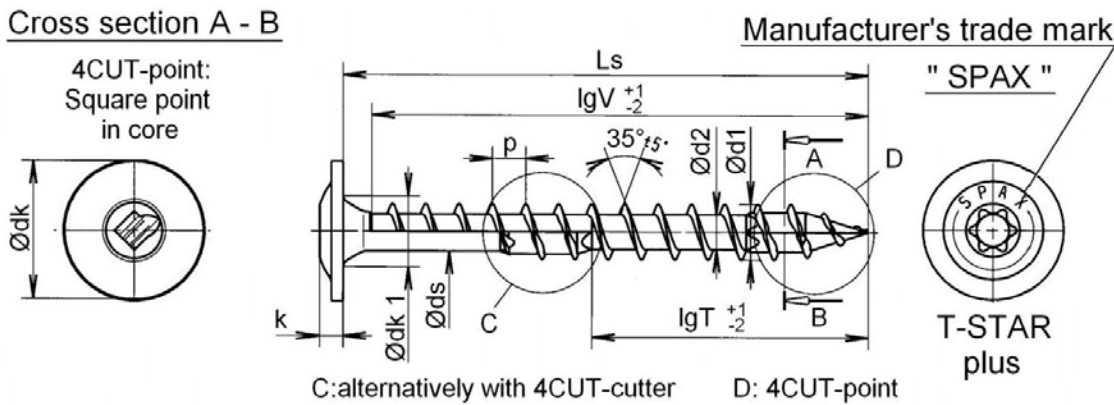

	 SPAX [®] Pan head	Self-tapping screw with full and partial thread Material: cold rolled wire according to SPAX - factory standard Screws of high carbon steel					
		Cross section A-B 4CUT-point: Square point in core					
		C: alternatively with 4CUT-cutter		D: 4CUT-point			
Nominal diameter		8.0	10.0				
d1	thread size	8.1	10.0				
	permissible tolerance	±0.4	±0.5				
dk	head diameter	15.5	19.0				
	permissible tolerance	±0.75	±0.95				
d2	core diameter	5.0	6.7				
	permissible tolerance	±0.30					
ds	shank diameter	5.7	6.8				
	permissible tolerance	±0.25					
k	head height max.	6.0	7.1				
p	thread pitch	4.8	6.0				
	permissible tolerance	±0.1 x p					
T-STAR plus size		T40	T50				
Ls		Standard thread lengths (full thread: -lgV / partial thread: -lgT)					
Nom. size	min	max	lgV	lgT	gV	gT	
40.0	38.5	41.5	37.0				
45.0	43.5	56.5	42.0				
50	48.5	51.5	46.0	32.0	40.0		
55	53.5	56.5	51.0	32.0	45.0		
60	58.5	61.5	56.0	37.0	50.0		
65	63.5	66.5	61.0	37.0	55.0		
70	68.5	71.5	61.0	42.0	60.0		
75	73.5	76.5	70.0	42.0	60.0		
80	78.5	81.5	70.0	47.0	70.0	50.0	
90	88.5	91.5	80.0	52.0	80.0	55.0	
100	98.5	101.5	80.0	57.0	80.0	60.0	
110	108.5	111.5	80.0	70.0	80.0	80.0	
120	118.5	121.5	80.0	70.0	80.0	80.0	
130	128.0	132.0	80.0	70.0	80.0	80.0	
140	138.0	142.0		80.0		80.0	
150	148.0	152.0		80.0		80.0	
160	158.0	162.0		80.0		80.0	
180	178.0	182.0		80.0		80.0	
200	198.0	202.0		80.0		80.0	
40							
600	597.0	602.0		80.0		80.0	
Intermediate lengths on Ls possible				Other thread lengths in the range 24xdl to max. standard length permitted			
Annex A35							



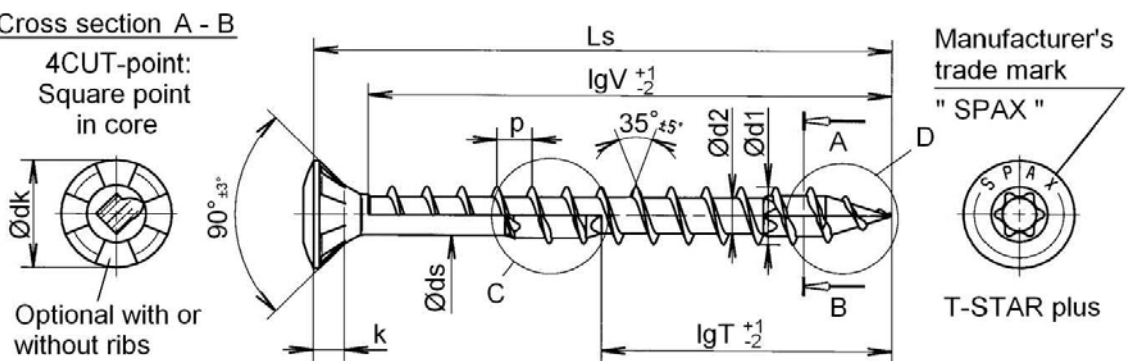



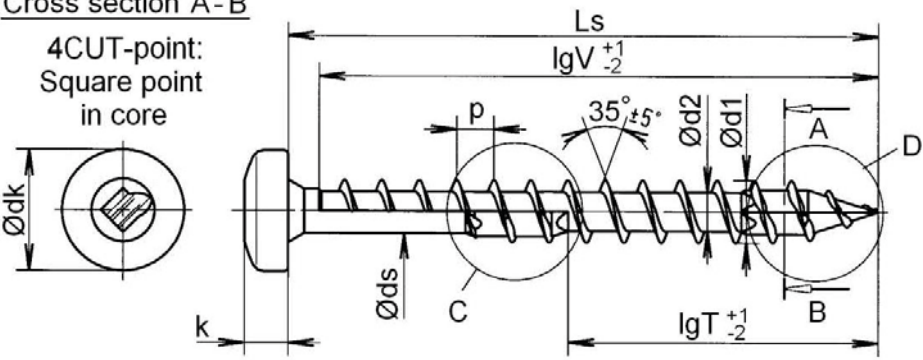

 SPAX® Hex. Head with/without flange		Self-tapping screw with full and partial thread									
		Material: cold rolled wire according to SPAX Factory standard Screws of high carbon steel									
 <p>C: alternatively with 4CUT-cutter D: 4CUT-point</p>											
		with flange	without flange	with flange	without flange						
Nominal diameter		8,0	8,0	10,0	10,0						
d1	thread size	8,1	8,1	10,0	10,0						
	permissible tolerance	+0,4	+0,4	+0,5	+0,5						
SW	wrench size	10	10	13	13						
Dc	flange diameter	16,5	-	30,8	-						
	permissible tolerance	+0,8	-	+1,0	-						
d ^o	core diameter	5,0	5,0	6,1	6,1						
	permissible tolerance	+0,3	+0,3	+0,3	+0,3						
dk	shank diameter	5,7	5,7	6,8	6,8						
	permissible tolerance	+0,25	+0,25	+0,25	+0,25						
k	head height max.	4,4	4,4	9,7	7,0						
p	thread pitch	4,8	4,8	6,0	6,0						
	permissible tolerance	+0,1 x p	+0,1 x p	+0,1 x p	+0,1 x p						
Ls		Standard thread lengths (full thread - lgV / partial thread - lgT)									
Nom. dim.	min	max	lgV	lgT							
40	38,5	41,5	32,0		32,0						
45	43,5	46,5	37,0		37,0						
50	48,5	51,5	42,0	32,0	42,0	32,0		40,0		40,0	
55	53,5	56,5	47,0	32,0	47,0	32,0		45,0		45,0	
60	58,5	61,5	52,0	37,0	52,0	37,0		50,0		50,0	
65	63,5	66,5	57,0	37,0	57,0	37,0		55,0		55,0	
70	68,5	71,5	61,0	42,0	61,0	42,0		60,0		60,0	
75	73,5	76,5	61,0	42,0	61,0	42,0		60,0		60,0	
80	78,5	81,5	70,0	47,0	70,0	47,0		70,0	50,0	70,0	50,0
90	88,5	91,5	80,0	52,0	80,0	52,0		80,0	55,0	80,0	55,0
100	98,5	101,5	80,0	57,0	80,0	57,0		80,0	60,0	80,0	60,0
110	108,5	111,5	80,0	70,0	80,0	70,0		80,0	80,0	80,0	80,0
120	118,5	121,5	80,0	70,0	80,0	70,0		80,0	80,0	80,0	80,0
150	128,0	132,0	80,0	70,0	80,0	70,0		80,0	80,0	80,0	80,0
140	138,0	142,0		80,0		80,0			80,0		80,0
150	148,0	152,0		80,0		80,0			80,0		80,0
160	158,0	162,0		80,0		80,0			80,0		80,0
180	178,0	182,0		80,0		80,0			80,0		80,0
200	198,0	202,0		80,0		80,0			80,0		80,0
to				80,0							80,0
600	597,0	602,0		80,0		80,0			80,0		80,0
Intermediate lengths on Ls possible			Other thread lengths in the range 7-48x1 to max. standard length permitted								
Annex A36											

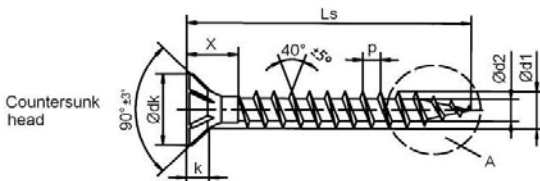
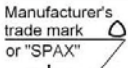
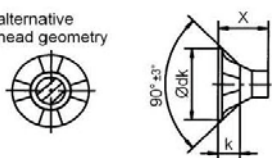

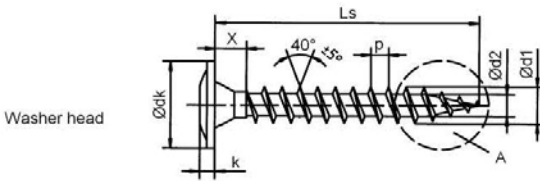
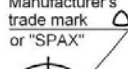

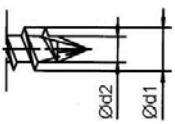
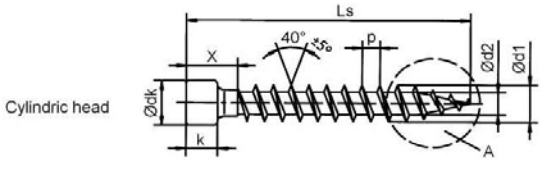
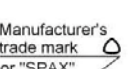

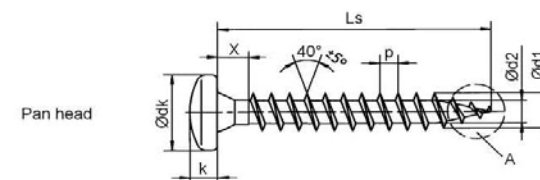
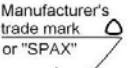

	SPAX® Flat countersunk head		Self-tapping screw with full and partial thread Material: cold rolled wire according to SPAX - Factory standard Stainless steel screws																
	Cross section A - B 4CUT-point: Square point in core  Optional with or without ribs									Manufacturer's trade mark "SPAX"  T-STAR plus									
			C: alternatively with 4CUT-cutter			D: 4CUT-point													
Nominal diameter			8,0		10,0														
d1	thread size		8,1		10,0														
	permissible tolerance		±0,4		±0,5														
dk	head diameter		15,1		18,6														
	permissible tolerance		±0,75		±0,93														
d2	core diameter		5,3		6,1														
	permissible tolerance		±0,30																
ds	shank diameter		5,70		6,80														
	permissible tolerance		±0,25																
k	head height max.		4,4		6,0														
p	thread pitch		4,8		6,0														
	permissible tolerance		±0,1 x p																
T-STAR plus size			T40		T50														
Ls			Standard thread lengths (full thread=lgV / partial thread = lgT)																
Nom. dim.			min		max		lgV		lgT		lgV		lgT						
40			38,5		41,5		32,0												
45			43,5		46,5		37,0												
50			48,5		51,5		42,0		32,0		40,0								
55			53,5		56,5		47,0		32,0		45,0								
60			58,5		61,5		52,0		37,0		50,0								
65			63,5		66,5		57,0		37,0		55,0								
70			68,5		71,5		61,0		42,0		60,0								
75			73,5		76,5		61,0		42,0		60,0								
80			78,5		81,5		70,0		47,0		70,0		50,0						
90			88,5		91,5		80,0		52,0		80,0		55,0						
100			98,5		101,5		80,0		57,0		80,0		60,0						
110			108,5		111,5		80,0		70,0		80,0		80,0						
120			118,5		121,5		80,0		70,0		80,0		80,0						
130			128,0		132,0		80,0		70,0		80,0		80,0						
140			138,0		142,0				80,0				80,0						
150			148,0		152,0				80,0				80,0						
160			158,0		162,0				80,0				80,0						
180			178,0		182,0				80,0				80,0						
200			197,0		202,0				80,0				80,0						
to																			
600			597,0		602,0				80,0				80,0						
Intermediate lengths on Ls possible										Other thread lengths in the range ≥4xd1 to max. standard length permitted									
Annex A37																			

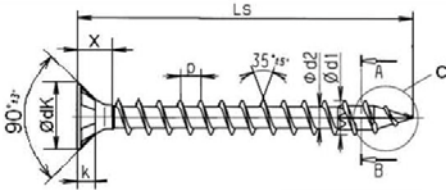

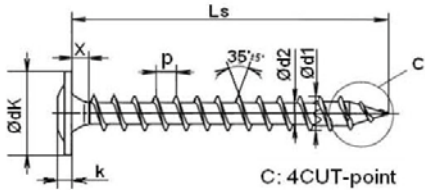

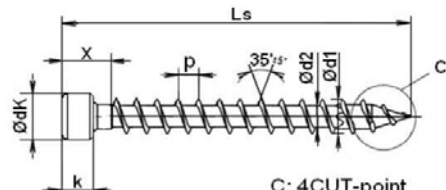

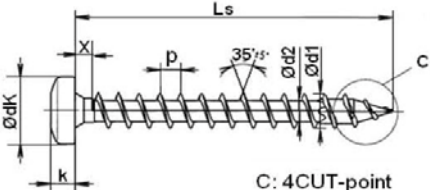

	 Washer head	Self-tapping screw with full and partial thread Material: cold rolled wire according to SPAX - Factory standard Stainless steel screws						
	<p>Cross section A - B</p> <p>4CUT-point: Square point in core</p>  <p>C: alternatively with 4CUT-cutter D: 4CUT-point</p>		<p>Manufacturer's trade mark</p> <p>" SPAX "</p>  <p>T-STAR plus</p>					
Nominal diameter	8,0		10,0					
d1	thread size	8,1		10,0				
	permissible tolerance	±0,4		±0,5				
dk	head diameter	18,0	20,0	22,0	24,0	23,0	25,0	27,0
	permissible tolerance	±0,9	±1,0	±1,1	±1,2	±1,15	±1,25	±1,35
dk1	countersink diameter	9,00				12,00		
	permissible tolerance	+0,50				+0,5		
d2	core diameter	5,3				6,1		
	permissible tolerance	±0,3				±0,3		
ds	shank diameter	5,70				6,80		
	permissible tolerance	±0,25				±0,25		
k	head height max.	4,3				4,7		
p	thread pitch	4,8				6,0		
	permissible tolerance	±0,1 x p				±0,1 x p		
T-STAR plus size		T40				T50		
Ls		Standard thread lengths (full thread=lgV / partial thread = lgT)						
Nom.dim.	min	max	lgV	lgT	lgV	lgT		
40	37,5	41,5	37,0					
45	43,5	46,5	42,0					
50	48,5	51,5	46,0	32,0	40,0			
55	53,5	56,5	51,0	32,0	45,0			
60	58,5	61,5	56,0	37,0	50,0			
65	63,5	66,5	61,0	37,0	55,0			
70	68,5	71,5	61,0	42,0	60,0			
75	73,5	76,5	70,0	42,0	70,0			
80	78,5	81,5	70,0	47,0	70,0		50,0	
90	88,5	91,5	80,0	52,0	80,0		55,0	
100	98,5	101,5	80,0	57,0	80,0		60,0	
110	108,5	111,5	80,0	70,0	80,0		80,0	
120	118,5	121,5	80,0	70,0	80,0		80,0	
130	128,0	132,0	80,0	70,0	80,0		80,0	
140	138,0	142,0		80,0			80,0	
150	148,0	152,0		80,0			80,0	
160	158,0	162,0		80,0			80,0	
180	178,0	182,0		80,0			80,0	
200	197,0	202,0		80,0			80,0	
<i>to</i>								
600	597,0	602,0		80,0			80,0	
Intermediate lengths on Ls possible				Other thread lengths in the range ≥4xd1 to max. standard length permitted				
 = Preferred size								
Annex A38								

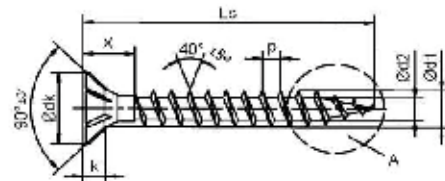
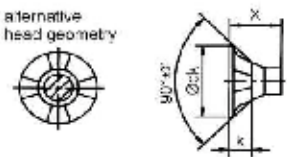
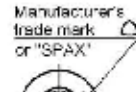

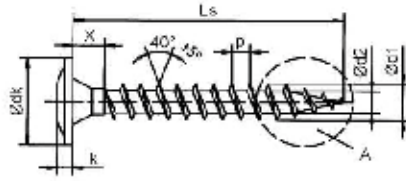

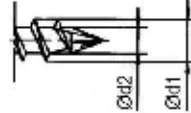
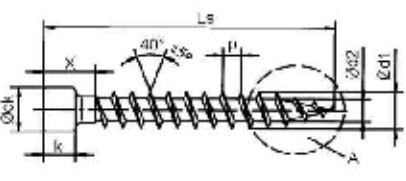
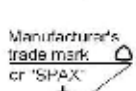
 SPAX [®] Raised countersunk head	Self-tapping screw with full and partial thread Material: cold rolled wire according to SPAX - Factory standard Stainless steel screws																		
<p>Cross section A - B</p> <p>4CUT-point: Square point in core</p> <p>Optional with or without ribs</p> <p>90° ±3°</p> <p>35° ±5°</p> <p>Manufacturer's trade mark "SPAX"</p> <p>T-STAR plus</p> <p>C: alternatively with 4CUT-cutter D: 4CUT-point</p> 																			
Nominal diameter	8,0	10,0																	
d1	thread size	8,1	10,0																
	permissible tolerance	±0,4	±0,5																
dk	head diameter	15,1	18,6																
	permissible tolerance	±0,75	±0,93																
d2	core diameter	5,3	6,1																
	permissible tolerance	±0,3	±0,3																
ds	shank diameter	5,70	6,80																
	permissible tolerance	±0,25	±0,25																
k	head height max.	4,4	6,0																
p	thread pitch	4,8	6,0																
	permissible tolerance	±0,1 x p	±0,1 x p																
T-STAR plus size		T40	T50																
Ls		Standard thread lengths (full thread=lgV / partial thread = lgT)																	
Nom. dim.	min	max	lgV	lgT	lgV	lgT													
40	38,5	41,5	32,0																
45	43,5	46,5	37,0																
50	48,5	51,5	42,0	32,0	40,0														
55	53,5	56,5	47,0	32,0	45,0														
60	58,5	61,5	52,0	37,0	50,0														
65	63,5	66,5	57,0	37,0	55,0														
70	68,5	71,5	61,0	42,0	60,0														
75	73,5	76,5	61,0	42,0	60,0														
80	78,5	81,5	70,0	47,0	70,0	50,0													
90	88,5	91,5	80,0	52,0	80,0	55,0													
100	98,5	101,5	80,0	57,0	80,0	60,0													
110	108,5	111,5	80,0	70,0	80,0	80,0													
120	118,5	121,5	80,0	70,0	80,0	80,0													
130	128,0	132,0	80,0	70,0	80,0	80,0													
140	138,0	142,0		80,0	80,0														
150	148,0	152,0		80,0	80,0														
160	158,0	162,0		80,0	80,0														
180	178,0	182,0		80,0	80,0														
200	198,0	202,0		80,0	80,0														
to																			
600	597,0	602,0		80,0	80,0														
Intermediate lengths on Ls possible										Other thread lengths in the range ≥4xd1 to max. standard length permitted									
Annex A39																			

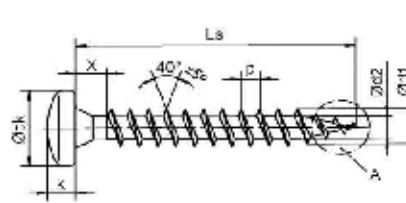
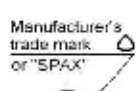



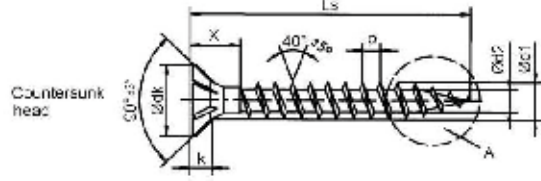
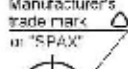
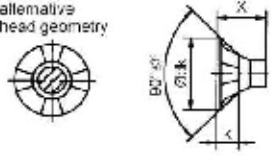
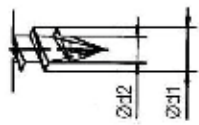
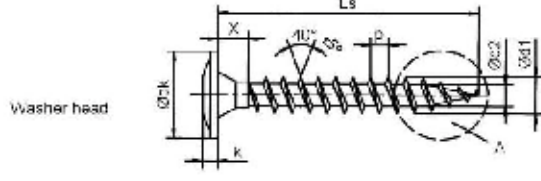

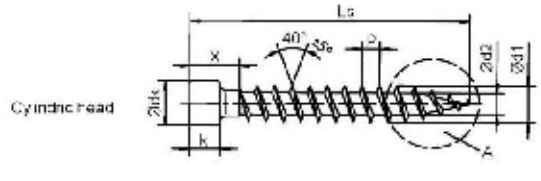
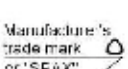
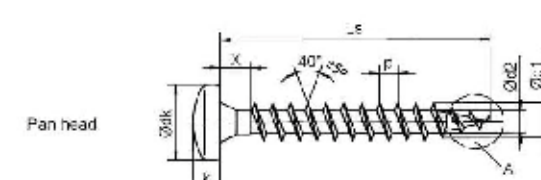
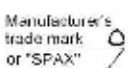
	 Pan head	Self-tapping screw with full and partial thread Material: cold rolled wire according to SPAX - Factory standard Stainless steel screws					
	Cross section A-B 4CUT-point: Square point in core						Manufacturer's trade mark "SPAX"  T-STAR plus
		C: alternatively with 4CUT-cutter		D: 4CUT-point			
Nominal diameter		8,0	10,0				
d1	thread size	8,1	10,0				
	permissible tolerance	±0,4	±0,5				
dk	head diameter	15,5	19,0				
	permissible tolerance	±0,77	±0,95				
d2	core diameter	5,3	6,1				
	permissible tolerance	±0,3	±0,3				
ds	shank diameter	5,70	6,80				
	permissible tolerance	±0,25	±0,25				
k	head height max.	6,0	7,1				
p	thread pitch	4,8	6,0				
	permissible tolerance	±0,1 x p	±0,1 x p				
T-STAR plus size		T40	T50				
Ls		Standard thread lengths (full thread=lgV / partial thread = lgT)					
Nom. dim.	min	max	lgV	lgT	lgV	lgT	
40	38,5	41,5	37,0				
45	43,5	46,5	42,0				
50	48,5	51,5	46,0	32,0	40,0		
55	53,5	56,5	51,0	32,0	45,0		
60	58,5	61,5	56,0	37,0	50,0		
65	63,5	66,5	61,0	37,0	55,0		
70	68,5	71,5	61,0	42,0	60,0		
75	73,5	76,5	70,0	42,0	60,0		
80	78,5	81,5	70,0	47,0	70,0	50,0	
90	88,5	91,5	80,0	52,0	80,0	55,0	
100	98,5	101,5	80,0	57,0	80,0	60,0	
110	108,5	111,5	80,0	70,0	80,0	80,0	
120	118,5	121,5	80,0	70,0	80,0	80,0	
130	128,0	132,0	80,0	70,0	80,0	80,0	
140	138,0	142,0		80,0		80,0	
150	148,0	152,0		80,0		80,0	
160	158,0	162,0		80,0		80,0	
180	178,0	182,0		80,0		80,0	
200	198,0	202,0		80,0		80,0	
to							
600	597,0	202,0		80,0		80,0	
Intermediate lengths on Ls possible				Other thread lengths in the range ≥4xd1 to max. standard length permitted			
Annex A40							



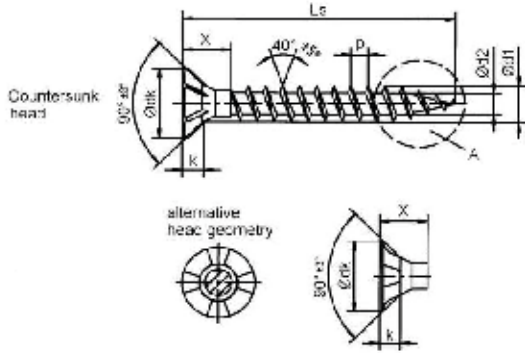
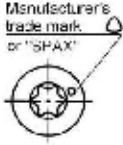
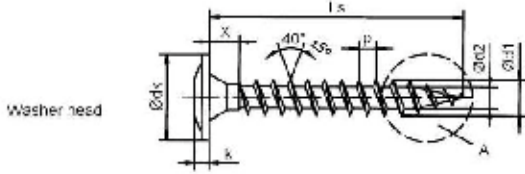

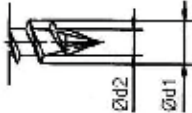
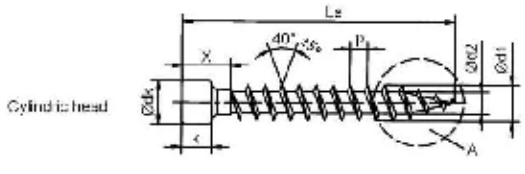

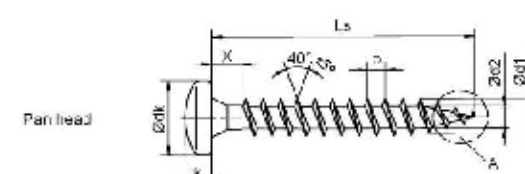

 SPAX®-S		Self-tapping screw with full-thread						
		Material: Cold rolled wire according to SPAX - Factory Standard Screws of high-carbon steel						
 <p>Countersunk head</p>		 <p>Manufacturer's trade mark or "SPAX"</p>						
 <p>alternative head geometry</p>		 <p>T-STAR or T-STAR plus</p>						
 <p>Washer head</p>		 <p>Manufacturer's trade mark or "SPAX"</p>						
 <p>T-STAR or T-STAR plus</p>					 <p>A: alternatively with CUT-point</p>			
 <p>Cylindric head</p>		 <p>Manufacturer's trade mark or "SPAX"</p>						
 <p>T-STAR or T-STAR plus</p>								
 <p>Pan head</p>		 <p>Manufacturer's trade mark or "SPAX"</p>						
 <p>T-STAR or T-STAR plus</p>								
Nominal diameter		6,0						
Type of Head		Countersunk head		Washer head		Cylindric head	Pan head	
d1	thread size	6,0						
	permissible tolerance	±0,3						
dk	head diameter	9,7	11,6	13,0	15,0	8,4	9,9	11,9
	permissible tolerance	±0,6		±0,65	±0,75		±0,6	
d2	core diameter	3,8						
	permissible tolerance	±0,3						
k	head height max.	2,9	3,8	2,2	2,4	6,0	3,4	4
p	thread pitch	3,0						
	permissible tolerance	±0,1 x p						
T-STAR	size	T20		T30			T20	T30
Thread-free length X	Ls 60-200	max. 15 mm						
permissible tolerance of screw length	Ls 60-99	Ls ±2 mm						
	Ls 100-200	Ls ±5 mm						
 =Preferred Version								
		Annex A41						

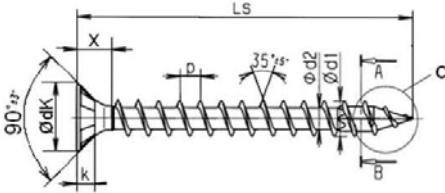
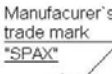

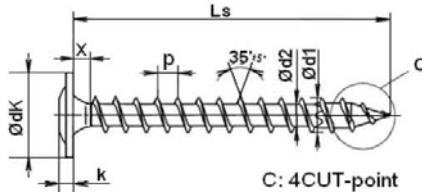
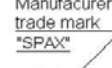

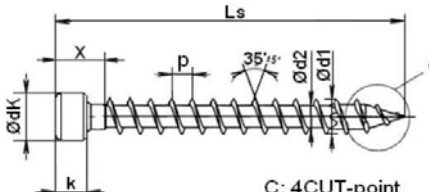

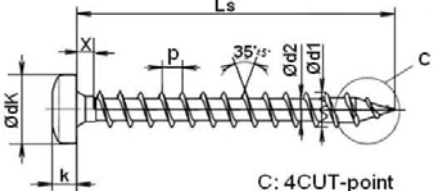
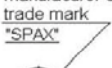
		Self-tapping screw with full- thread						
		Material: Cold rolled wire according to SPAX - Factory Standard Screws of high-carbon steel						
 <p>C: 4CUT-point</p>		 <p>Manufacturer's trade mark "SPAX" T-STAR plus</p>		<p>Cross sektion A-B</p>  <p>4CUT-point: Square point in core</p>				
 <p>C: 4CUT-point</p>		 <p>Manufacturer's trade mark "SPAX" T-STAR plus</p>						
 <p>C: 4CUT-point</p>		 <p>T-STAR plus</p>						
 <p>C: 4CUT-point</p>		 <p>Manufacturer's trade mark "SPAX" T-STAR plus</p>						
Nominal diameter		6,0						
Type of Head		Countersunk head		Washer head		Cylindric head	Pan head	
d1	thread size	6,0						
	permissible tolerance	±0,3						
dk	head diameter	9,7	11,6	13,0	15,0	8,4	9,9	11,9
	permissible tolerance	±0,6		±0,65	±0,75		±0,6	
d2	core diameter	3,9						
	permissible tolerance	±0,3						
k	head height max.	2,9	3,8	2,2	2,4	6,0	3,4	4
p	thread pitch	3,6						
	permissible tolerance	±0,1 x p						
T-STAR plus size		T20	T30				T20	T30
Thread-free length X		Ls 60-200		max. 15 mm				
permissible tolerance of screw length		Ls 60-99		Ls ±2 mm				
		Ls 100-200		Ls ±5 mm				
 =Preferred Version								
		Annex A42						





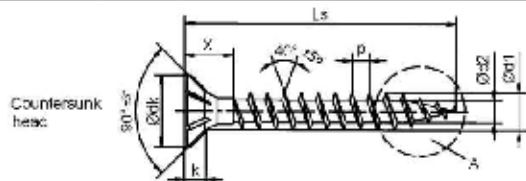
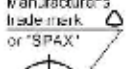
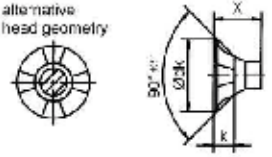
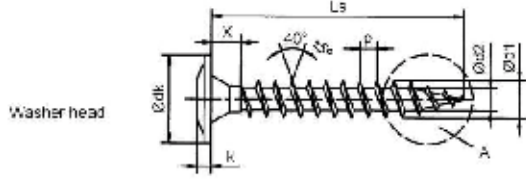

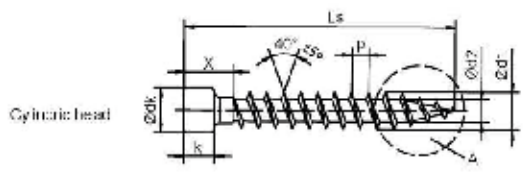
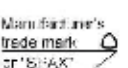
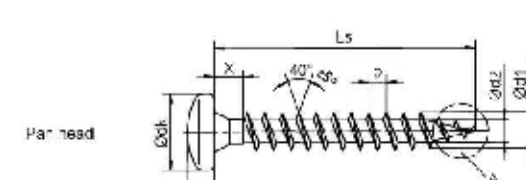
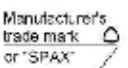
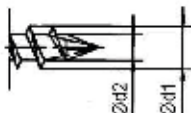

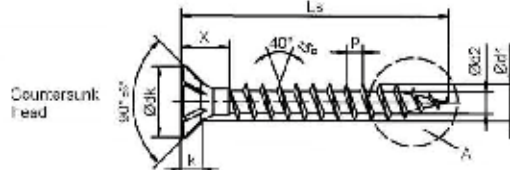
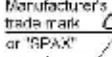

 SPAX[®]-S		Self-tapping screw with full-thread								
		Material: Cold rolled wire according to SPAX - Factory Standard Screws of high-carbon steel								
<p>Countersunk head</p>  <p>alternative head geometry</p> 										
	<p>Washer head</p> 									
										
	<p>Cylindric head</p> 									
<p>Pan head</p> 										
Nominal diameter		8,0								
Type of Head		Countersunk head		Washer head		Cylindric head		Pan head		
c1	thread size	8,1								
	permissible tolerance	±0,4								
c.k	head diameter	11,6	15,1	18,0	20,0	22,0	24,0	10,0	15,5	17,0
	permissible tolerance	±0,6	±0,75	±0,9	±1,0	±1,1	±1,2	±0,6	±0,75	±0,6
c.2	core diameter	5,0								
	permissible tolerance	±0,4								
k	head height max.	3,0	4,8	4,5		8,0	5,8	4,0		
p	thread pitch	4,0								
	permissible tolerance	10% x p								
T-STAR size		T40						T30		
Thread-free length X	Ls 60-200	max. 15 mm								
	Ls > 200	max. 25 mm								
permissible tolerance of screw length	Ls 60-99	± 2 mm								
	Ls 100-200	± 5 mm								
	Ls > 200	± 15 mm								
Screw lengths Ls up to 600 mm (Lengths > 400 mm with CU-I-point)				Preferred size						
Annex A43										

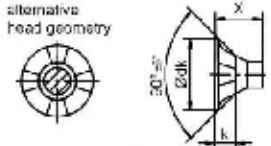
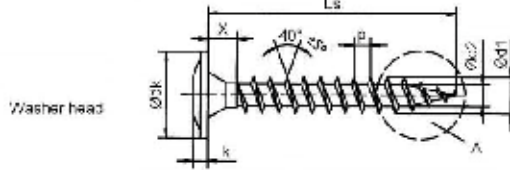
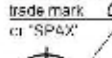

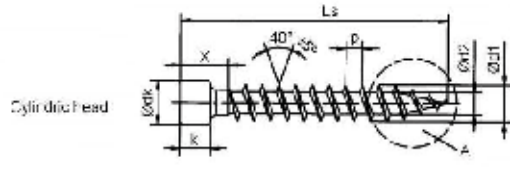
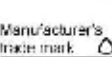

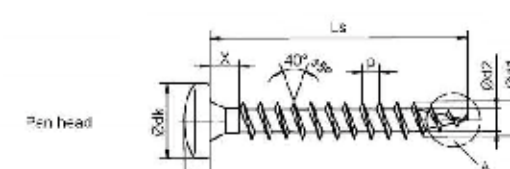
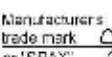

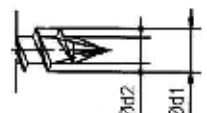
 SPAX®-S		Self-tapping screw with full-thread						
		Material: Cold rolled wire according to SPAX - Factory Standard Screws of high-carbon steel						
 <p>Countersunk head</p>		 Manufacturer's trade mark or "SPAX" T-STAR or T-STAR plus		 <p>alternative head geometry</p> <p>A: alternatively with CJT-point</p> 				
 <p>Washer head</p>		 Manufacturer's trade mark or "SPAX" T-STAR or T-STAR plus						
 <p>Cylindric head</p>		 Manufacturer's trade mark or "SPAX" T-STAR or T-STAR plus						
 <p>Pan head</p>		 Manufacturer's trade mark or "SPAX" T-STAR or T-STAR plus						
Nominal diameter		10,0						
Type of Head		Countersunk head	Washer head	Cylindric head	Pan head			
d1	thread size	10,0						
	permissible tolerance	±0,5						
dk	head diameter	15,1	18,6	20,0	25,0	12,0	19,0	15,5
	permissible tolerance	±0,75	±0,93	±1,0	±1,25	±0,6	±0,95	±0,75
d2	core diameter	6,1						
	permissible tolerance	±0,3						
k	head height max.	4,2	6,0	5,0	5,0	10,0	7,1	5,8
p	thread pitch	5,0						
	permissible tolerance	0,1 x p						
T-STAR size		T50		T40		T50		T40
Thread-free length X		Ls 00-200 Ls > 200		max. 15 mm max. 25 mm				
permissible tolerance of screw length		Ls 00-99 Ls 100-200 Ls > 200		Ls = 2 mm Ls = 5 mm Ls 115 mm				
Screw lengths Ls to 850 mm possible				 - Preferred size				
						Annex A4 ⁴		

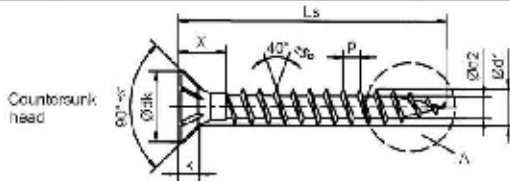
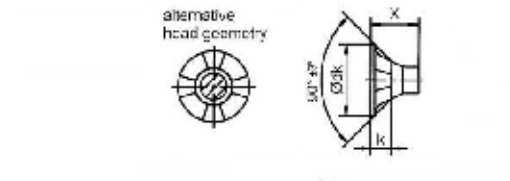
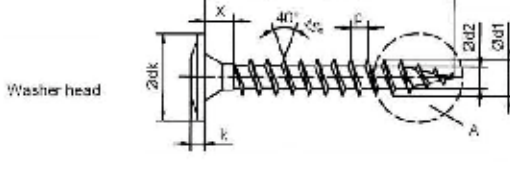
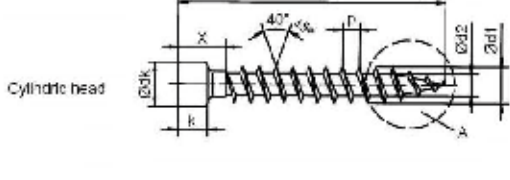

 SPAX[®]-S		Self-tapping screw with full-thread							
		Material: Cold rolled wire according to SPAX - Factory Standard Screws of high-carbon steel							
 <p>Countersunk head</p> <p>alternative head geometry</p>		 <p>Manufacturer's trade mark or "SPAX"</p> <p>T-STAR or T-STAR plus</p>							
 <p>Washer head</p>		 <p>Manufacturer's trade mark or "SPAX"</p> <p>T-STAR or T-STAR plus</p>		 <p>A: alternatively with CUT-point</p>					
 <p>Cylindric head</p>		 <p>Manufacturer's trade mark or "SPAX"</p> <p>T-STAR or T-STAR plus</p>							
 <p>Pan head</p>		 <p>Manufacturer's trade mark or "SPAX"</p> <p>T-STAR or T-STAR plus</p>							
Nominal diameter		12,0							
Type of Head		Countersunk head	Washer head	Cylindric head	Pan head				
d1	thread size	12,0							
	permissible tolerance	10,6							
dk	head diameter	18,6	22,6	25,0	29,0	14,0	23,0	19,0	
	permissible tolerance	0,93	1,13	1,25	1,45	0,7	1,13	0,95	
d2	core diameter	7,35							
	permissible tolerance	10,35							
k	head height max.	5,2	7,1	6,0	12,0	8,5	7,1		
p	thread pitch	6,0							
	permissible tolerance	0,1 x p							
T-STAR size		T50							
Thread-free length X	Ls 60-99	max 15 mm							
	Ls 100-200	max 20 mm							
	Ls > 200	max 25 mm							
permissible tolerance of screw length	Ls 60-99	Ls - 2 mm							
	Ls 100-200	Ls = 10 mm							
	Ls > 200	Ls + 15 mm							
Screw lengths Ls to 600 mm possible		 Preferred size							
Annex A45									

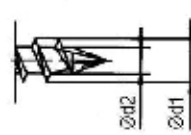
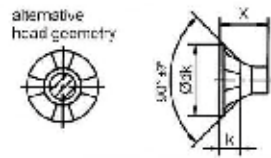
		Self-tapping screw with full- thread						
		Material: Cold rolled wire according to SPAX - Factory Standard Stainless steel screws						
 <p>C: 4CUT-point</p>		 Manufacturer's trade mark "SPAX"  T-STAR plus		<p>Cross section A-B</p>  <p>4CUT-point: Square point in core</p>				
 <p>C: 4CUT-point</p>		 Manufacturer's trade mark "SPAX"  T-STAR plus						
 <p>C: 4CUT-point</p>		 T-STAR plus						
 <p>C: 4CUT-point</p>		 Manufacturer's trade mark "SPAX"  T-STAR plus						
Nominal diameter		6,0						
Type of Head		Countersunk head		Washer head		Cylindric head	Pan head	
d1	thread size	6,1						
	permissible tolerance	±0,3						
dk	head diameter	9,7	11,6	13,0	15,0	8,4	11,9	9,9
	permissible tolerance	±0,6		±0,65	±0,75		±0,6	
d2	core diameter	4,0						
	permissible tolerance	±0,3						
k	head height max.	2,9	3,8	2,2	2,4	6,0	4,0	3,4
p	thread pitch	3,6						
	permissible tolerance	±0,1 x p						
T-STAR plus size		T30					T20	
Thread-free length X Ls 60-200		max. 15 mm						
permissible tolerance of screw length		Ls 60-99		Ls ±2 mm				
		Ls 100-200		Ls ±5 mm				
 =Preferred Version								
		Annex A46						

 		Self-tapping screw with full-thread								
		Material: Cold rolled wire according to SPAX Factory Standard Stainless steel screws								
 <p>Countersunk head</p>		 <p>Manufacturer's trade mark or "SPAX"</p>		 <p>alternative head geometry</p>						
 <p>Washer head</p>		 <p>Manufacturer's trade mark or "SPAX"</p>								
 <p>Cylindric head</p>		 <p>Manufacturer's trade mark or "SPAX"</p>								
 <p>Pan head</p>		 <p>Manufacturer's trade mark or "SPAX"</p>								
				 <p>A: alternatively with CUT-point</p>						
Nominal diameter		8.0								
Type of Head		Countersunk head	Washer head	Cylindric head	Pan head					
d1	thread size	8.1								
	permissible tolerance	+0.4								
dk	head diameter	11.6	15.1	16.0	20.0	22.0	24.0	16.0	15.5	11.9
	permissible tolerance	+0.6	+0.75	+0.9	+1.0	+1.1	+1.2	+0.6	+0.75	+0.6
d2	core diameter	5.0								
	permissible tolerance	±0.3								
k	head height max	3.0	4.8	4.5		8.0	5.8	4.0		
P	thread pitch	4.0								
	permissible tolerance	±0.1 x P								
I - STAR size		I40				I30				
I thread-free length X		Ls 60-200 Ls > 200		max. 15 mm max. 25 mm						
permissible tolerance of screw length		Ls 60-95 Ls 100-200 Ls > 200		Ls +2 mm Ls +5 mm Ls ±15 mm						
Screw lengths Ls up to 600 mm (Lengths > 400 mm with CUT-point)										
 - Preferred size										
Annex A47										

 SPAX-S		Self-tapping screw with full-thread						
		Material: Cold rolled wire according to SPAX - Factory Standard Stainless steel screws						
 <p>Countersunk head</p>		 <p>Manufacturer's trade mark or "SPAX"</p>		 <p>T-STAR or T-STAR plus</p>				
 <p>alternative head geometry</p>								
 <p>Washer head</p>		 <p>Manufacturer's trade mark or "SPAX"</p>		 <p>T-STAR or T-STAR plus</p>				
 <p>Cylindric head</p>		 <p>Manufacturer's trade mark or "SPAX"</p>		 <p>T-STAR or T-STAR plus</p>				
 <p>Pan head</p>		 <p>Manufacturer's trade mark or "SPAX"</p>		 <p>T-STAR or T-STAR plus</p>				
				 <p>A: alternatively with CUT-point</p>				
Nominal diameter		10,0						
Type of Head		Countersunk head		Washer head	Cylindric head	Pan head		
d1	thread size	10,0						
	permissible tolerance	-0,5						
dk	head diameter	15,1	18,6	20,0	25,0	12,0	19,0	15,5
	permissible tolerance	+0,75	+0,93	-1,0	+1,25	+0,6	+0,95	+0,77
d2	core diameter	6,1						
	permissible tolerance	±0,3						
k	head height max.	4,2	6,0	5,0	5,0	10,0	7,1	5,8
p	thread pitch	5,0						
	permissible tolerance	0,1 x p						
T-STAR	size	T50		T40	T50	T40		
Thread free length X	Ls 60-200	max. 15 mm						
	Ls > 200	max. 25 mm						
permissible tolerance of screw length	Ls 60-99	Ls ±2 mm						
	Ls 100-200	Ls ±5 mm						
	Ls > 200	Ls ±15 mm						
Screw lengths Ls to 800 mm possible						 Preferred size		
						Annex A48		

		Self-tapping screw with full-thread							
		Material: Cold rolled wire according to SPAX - Factory Standard Stainless steel screws							
 <p>Countersunk head</p>		 <p>Washer head</p>		 <p>Cylindric head</p>		 <p>Pan head</p>		 <p>Manufacturer's trade mark or "SPAX" T-STAR or T-STAR plus</p>	<p>A: alternatively with GLT-point</p> 
 <p>alternative head geometry</p>		 <p>Manufacturer's trade mark or "SPAX" T-STAR or T-STAR plus</p>		 <p>Manufacturer's trade mark or "SPAX" T-STAR or T-STAR plus</p>		 <p>Manufacturer's trade mark or "SPAX" T-STAR or T-STAR plus</p>			
Nominal diameter		12,0							
Type of Head		Countersunk head	Washer head	Cylindric head	Pan head				
d1	thread size	12,0							
	permissible tolerance	±0,6							
dk	head diameter	18,6	22,6	25,0	29,0	14,0	23,0	19,0	
	permissible tolerance	±0,75	±0,93	±1,25	±1,45	±0,7	±1,15	±0,95	
d2	core diameter	7,95							
	permissible tolerance	±0,35							
k	head height max	5,3	7,1	6,0	12,0	8,5	7,1		
p	thread pitch	6,0							
	permissible tolerance	±0,1 x p							
T-STAR size		T 50							
Thread-free length X	Ls 50-98	max. 15 mm							
	Ls 100-200	max. 20 mm							
	Ls > 200	max. 25 mm							
permissible tolerance of screw length	Ls 50-98	Ls - 2 mm							
	Ls 100-200	Ls - 10 mm							
	Ls > 200	Ls ± 15 mm							
Screw lengths Ls to 600 mm possible		 Preferred size							
Annex A19									

			Self-tapping screw with full- thread				
	Hex. head with/without flange		Material: Cold rolled wire according to SPAX - Factory Standard Screws of high-carbon steel				
Nominal diameter	8,0		10,0		12,0		
Type of Head	without flange	with flange	without flange	with flange	without flange	with flange	
SW wrench size	10		13		16		
k head height max.	6,00	8,5	7,00	9,7	8,00	12,1	
Dc diameter of flange	15,5		19,5		22,5		
permissible tolerance	±0,77		±0,97		±1,12		
d1 thread diameter	8,1		10,0		12,0		
permissible tolerance	±0,4		±0,5		±0,6		
d2 core diameter	5,0		6,1		7,35		
permissible tolerance	±0,3		±0,3		±0,35		
p thread pitch	4,0		5,0		6,0		
permissible tolerance	±0,1 x p		±0,1 x p		±0,1 x p		
thread-free length X	Ls 60-99	max. 15 mm		max. 15 mm		max. 15 mm	
	Ls 100-200	max. 15 mm		max. 15 mm		max. 20 mm	
	Ls > 200	max. 25 mm		max. 25 mm		max. 25 mm	
permissible tolerance of screw length	Ls 60-99	Ls ±2 mm				Ls ±2 mm	
	Ls 100-200	Ls ±5 mm				Ls ±10 mm	
	Ls > 200	Ls ±15 mm				Ls ±15 mm	
Screw lengths Ls up to 600 mm possible (at a nominal diameter of 8,0 mm lengths > 400 mm with CUT-point)							
Annex A50							

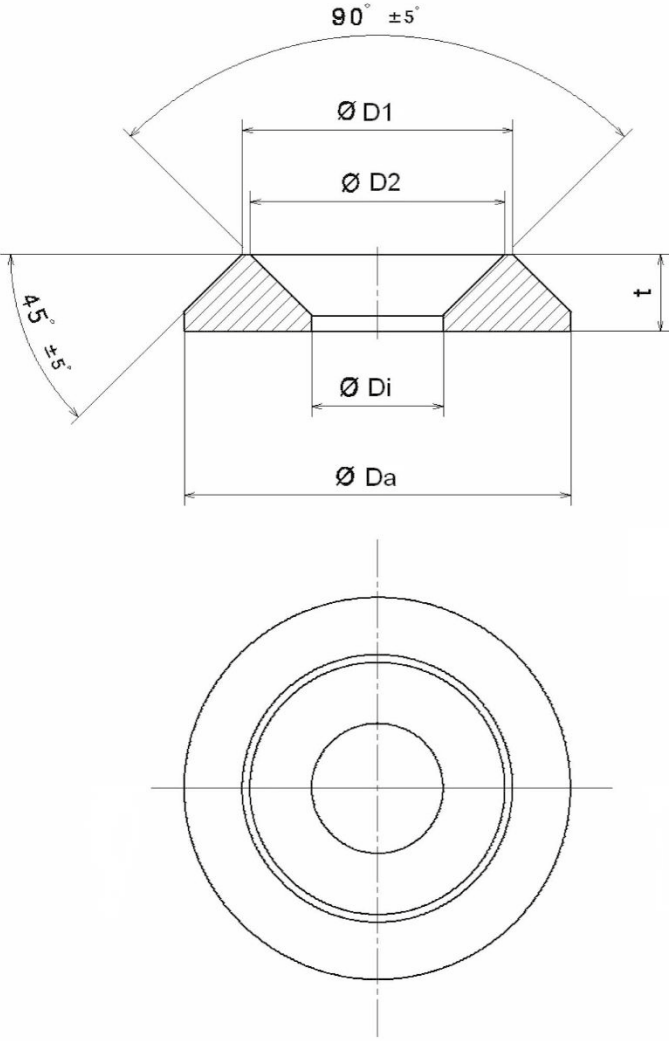
	SPAX [®] Washer	Washer for screws with countersunk and raised countersunk head			
		Material: machining steel Dimensions in mm			
					
Thread size	6,0	8,0	10,0	12,0	Tolerance
ØDa	18,0	25,0	32,0	40,0	± 0,3
ØDi	6,5	8,5	11,0	13,0	
ØD1	13,5	17,5	22,5	27,0	
ØD2	12,5	16,5	21,5	26,0	
t	3,5	5,0	5,6	7,0	
Annex A51					

	SPAX [®]	Threaded rod with full thread
		Material: Steel or Stainless steel

Design with hexagon head

L
800
1000
1200
1400
1600
1800
2000
2200

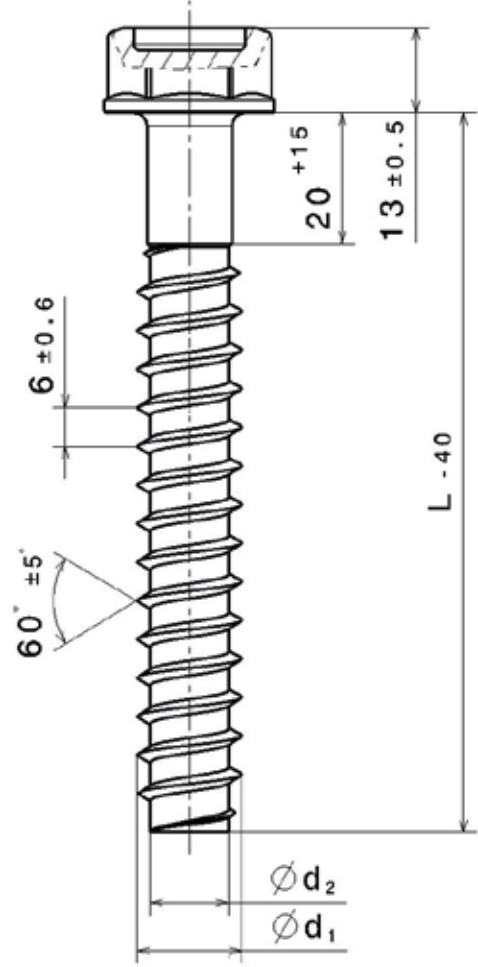

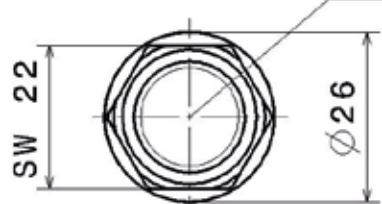

Manufacturer's trade mark:
ABC or SPAX



stainless steel	16 ±0.8	12 ±0.8
Steel	16 ±0.8	12 ±0.8
Execution	Ø d ₁	Ø d ₂

- Other lengths 100 - 3000 mm possible
 - Length can be changed by cutting the threaded part

Annex A52

		Threaded rod with full thread Material: steel or stainless steel
---	---	--

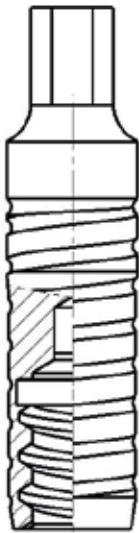

Screw adapter
available as accessory

Version without head

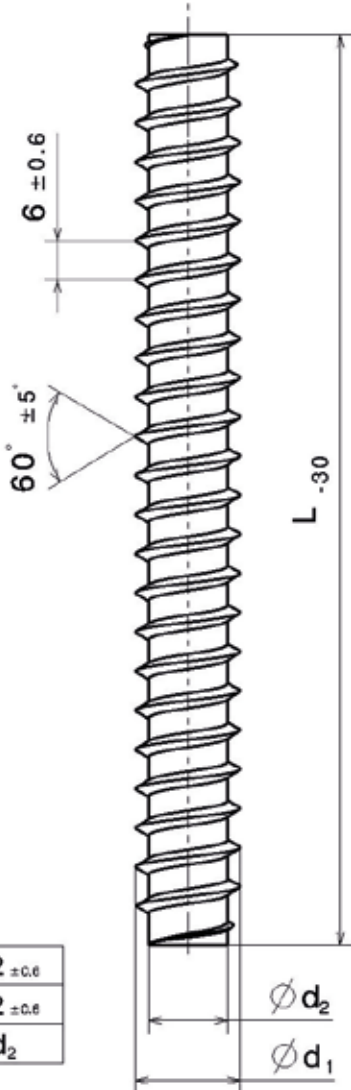

L
3000

stainless steel	16 ±0.6	12 ±0.6
Steel	16 ±0.6	12 ±0.6
Execution	Ø d ₁	Ø d ₂

- Other lengths 100 - 3000 mm possible
- Length can be changed by cutting the threaded part

Annex A53



SPAX[®]

Self-tapping screw with CUT-point

Material: cold rolled wire according to SPAX - Factory Standard
Screws of high carbon steel

Screw with CUT-point

Cross section A-B

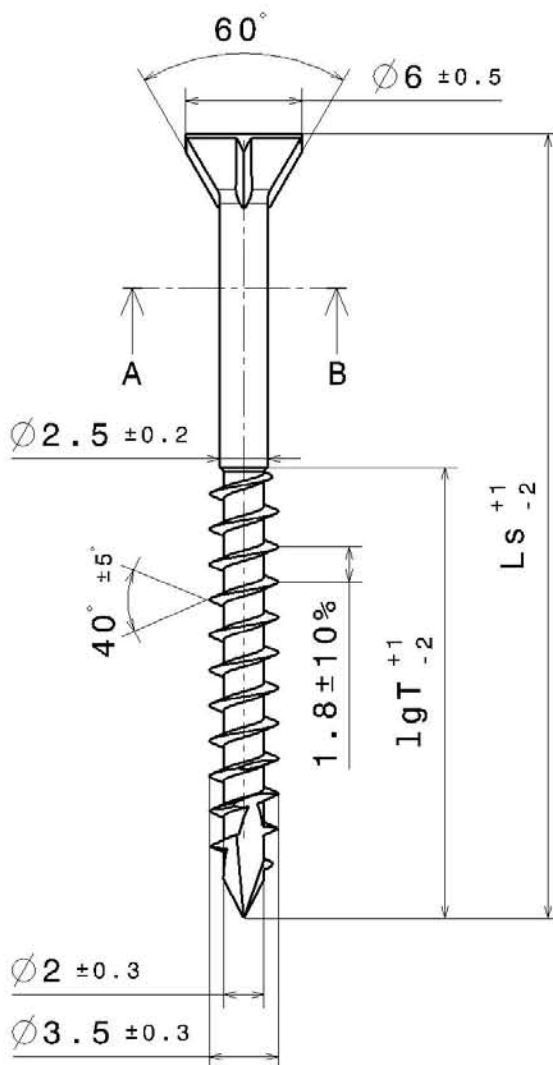
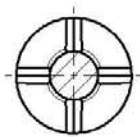

55	35
45	28
35	20
Ls	lgT*

*other thread lengths (lgT)
are acceptable if
lgT > 4 x 3,5

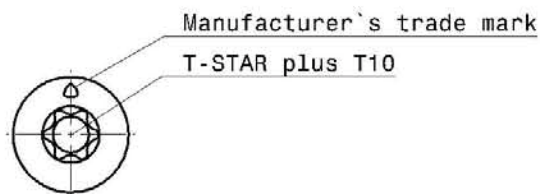

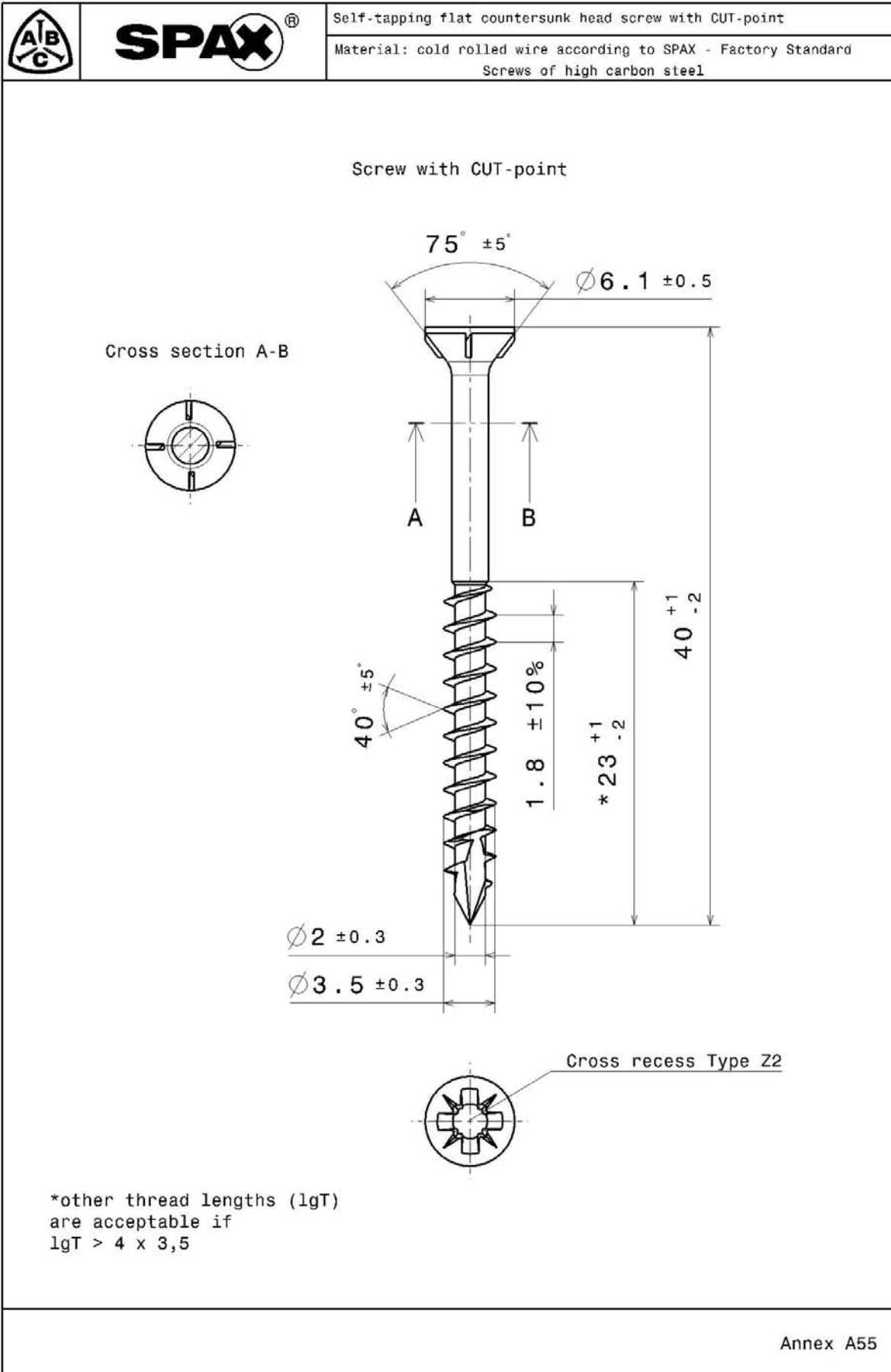

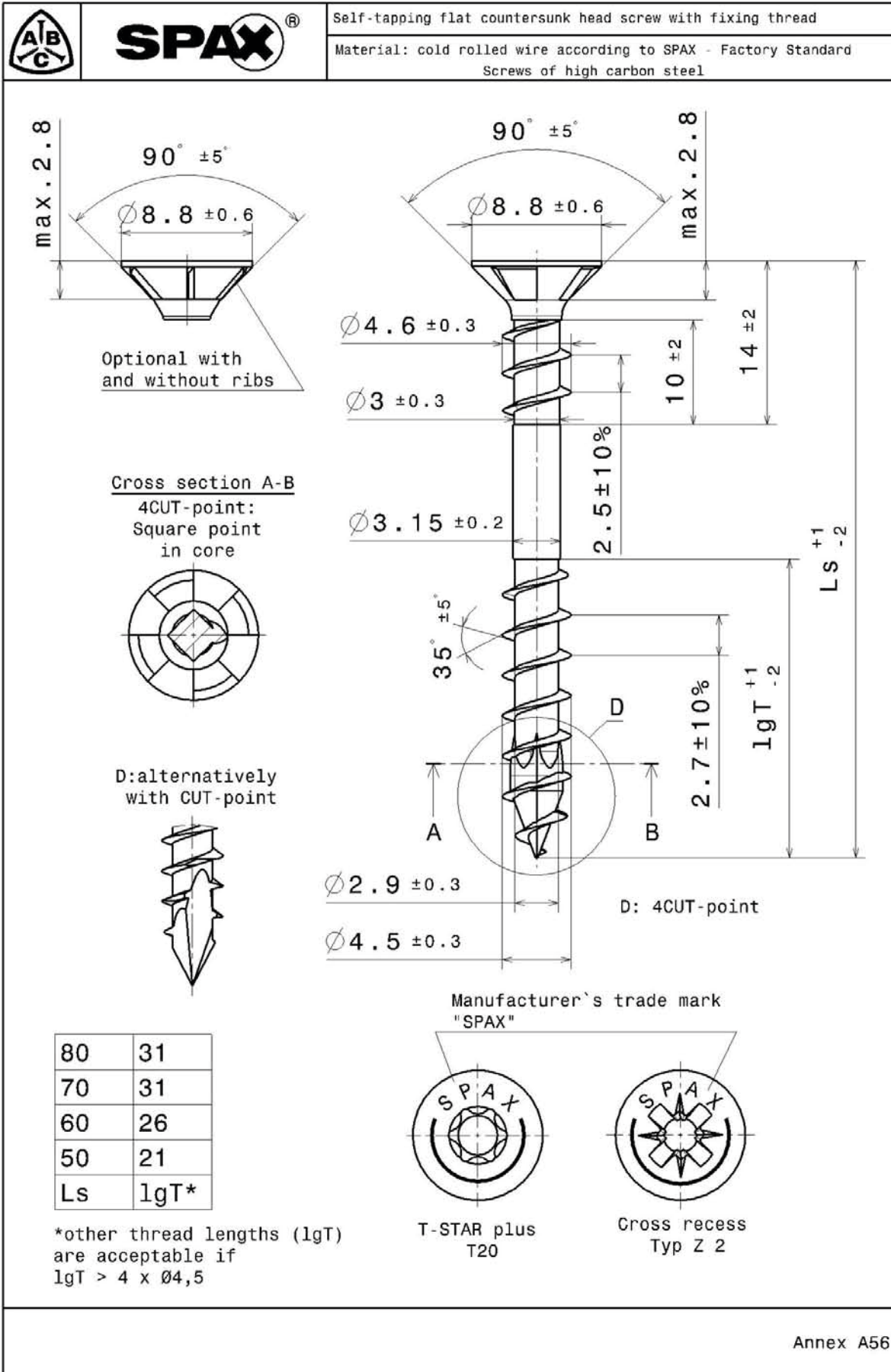

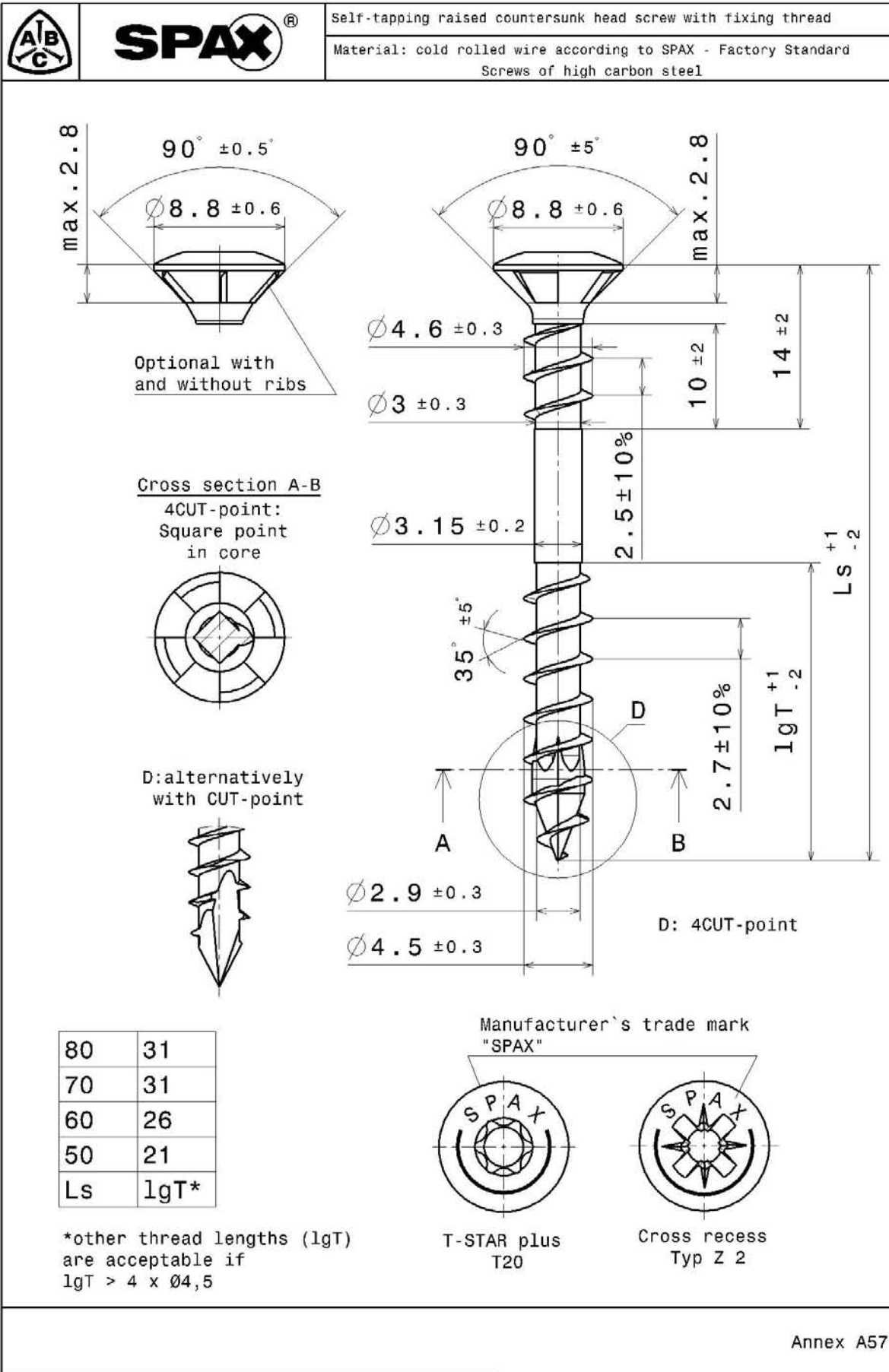

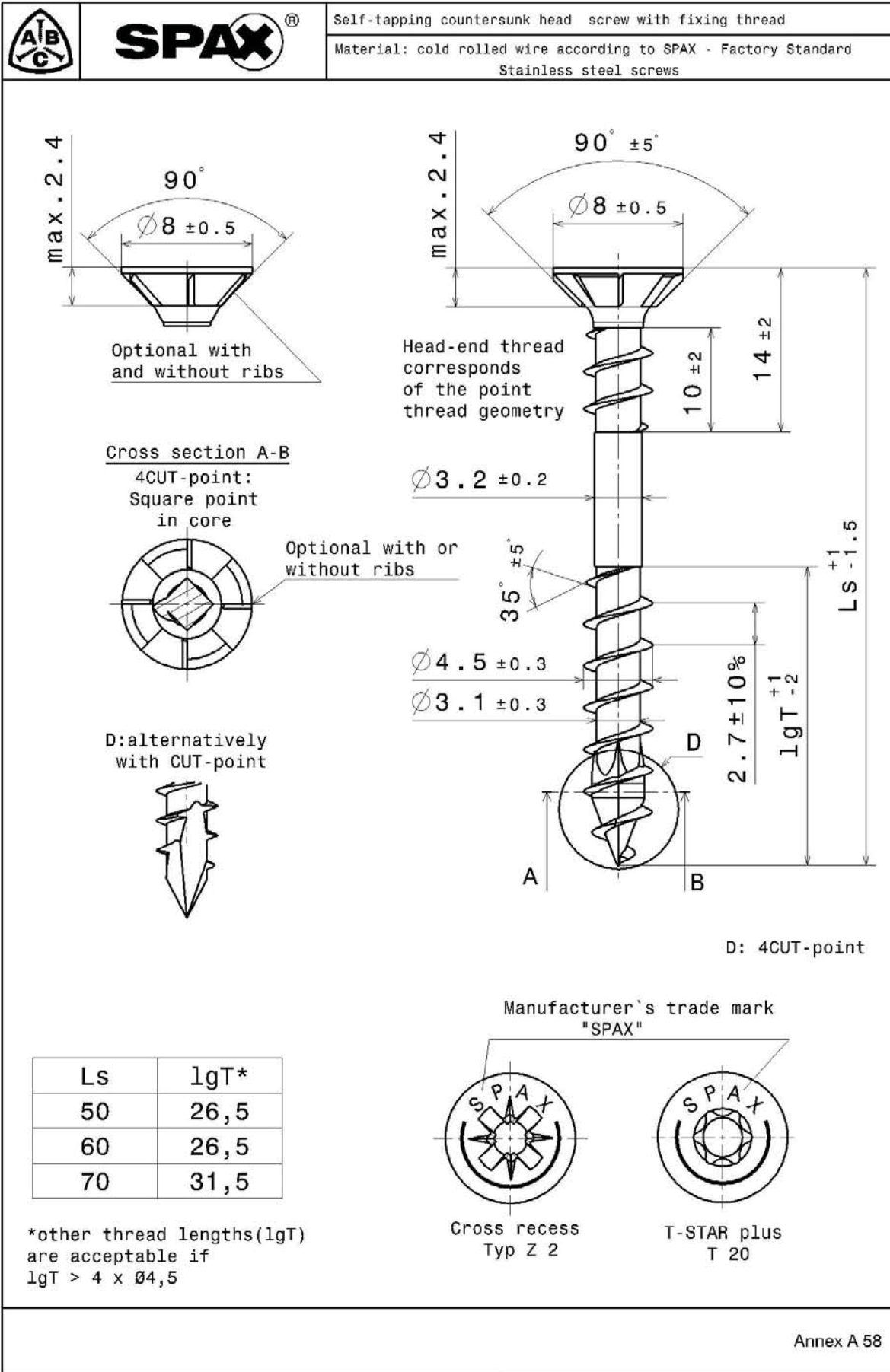

Annex A 58

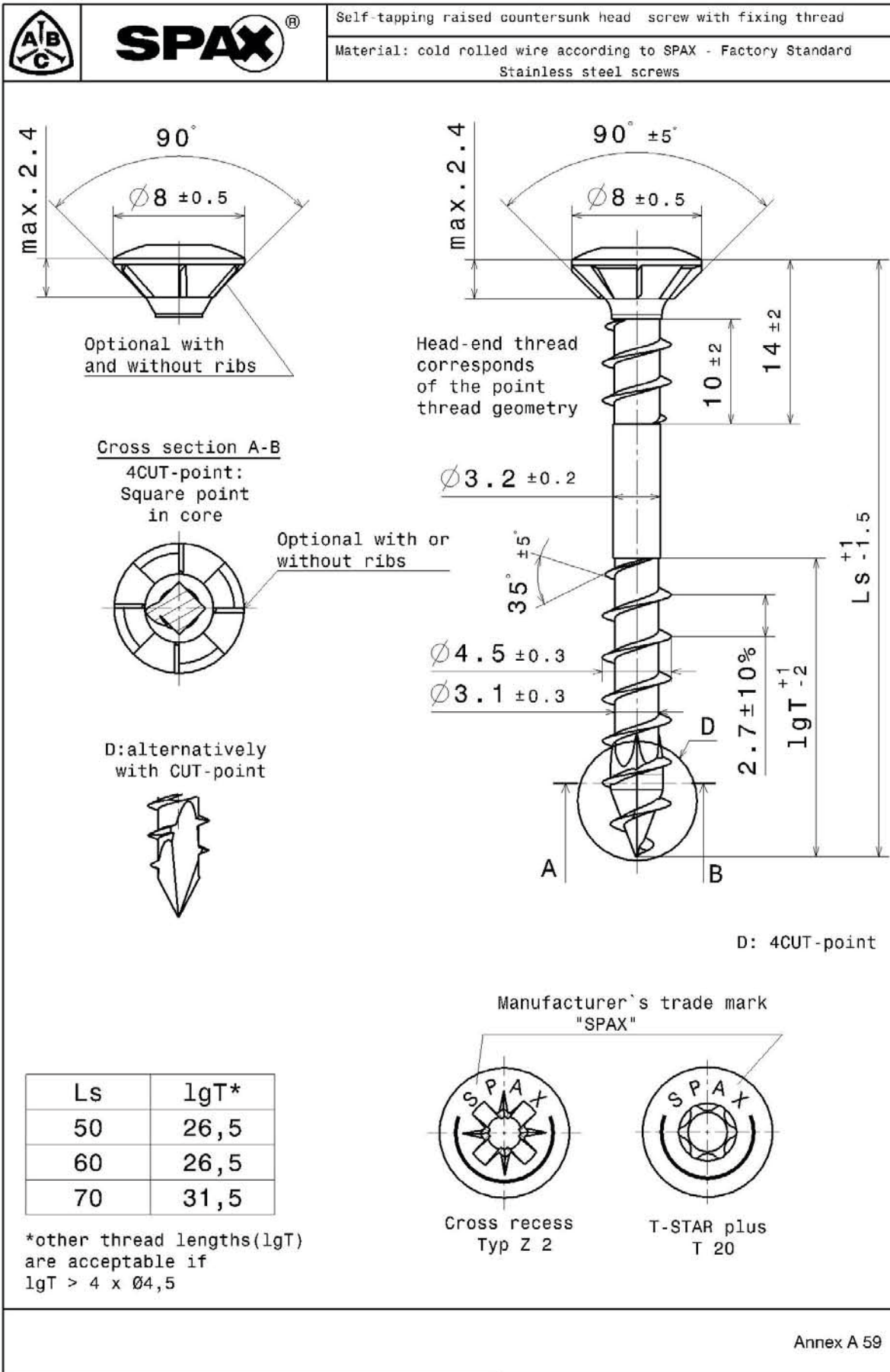

Annex A 59

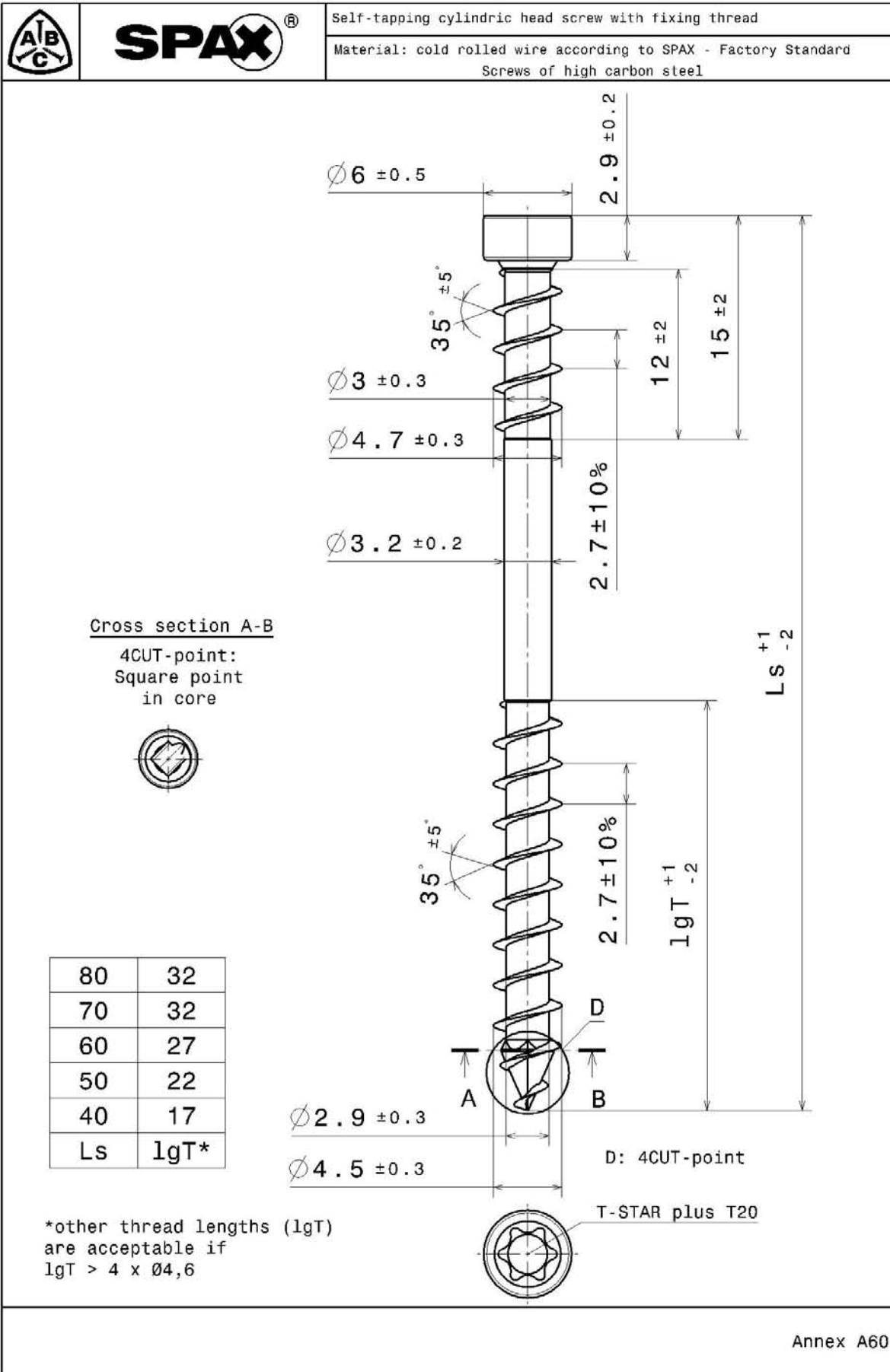



SPAX®

Self-tapping raised countersunk head screw with CUT-point

Material: cold rolled wire according to SPAX - Factory Standard
Stainless steel screws

Screws with CUT-point

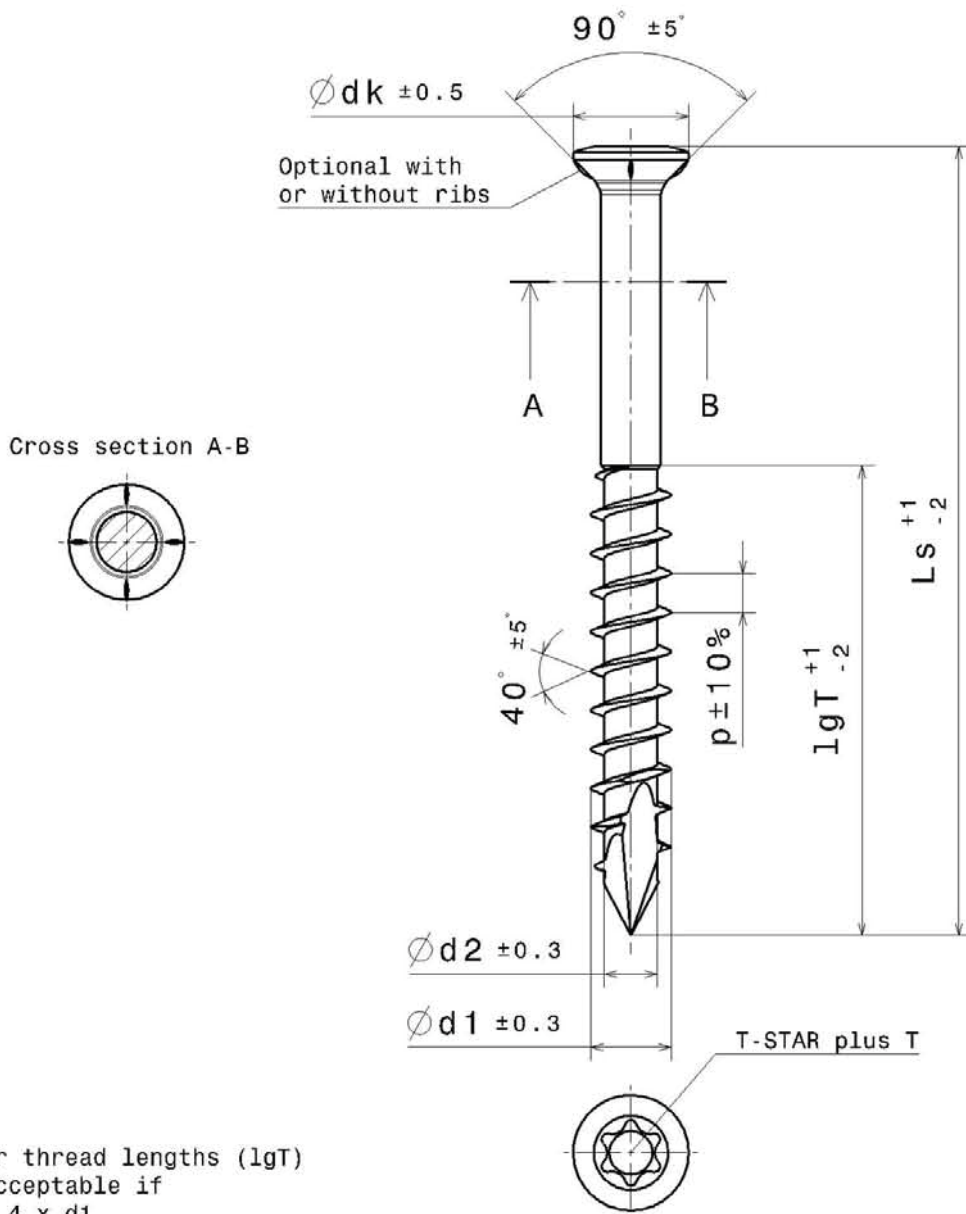

*other thread lengths (lgT) are acceptable if lgT > 4 x d1

5,0	3,3	8	T20	100	61	2,5
4,5	3	7	T15	70	42	2,2
4,0	2,7	6	T15	45	29	2
4,0	2,7	6	T15	40	24	2
d1	d2	dk	T	Ls	lgT*	p



SPAX®

Self-tapping cylindric head screw with fixing thread

Material: cold rolled wire according to SPAX - Factory Standard
Stainless steel screw

Screw with CUT-point

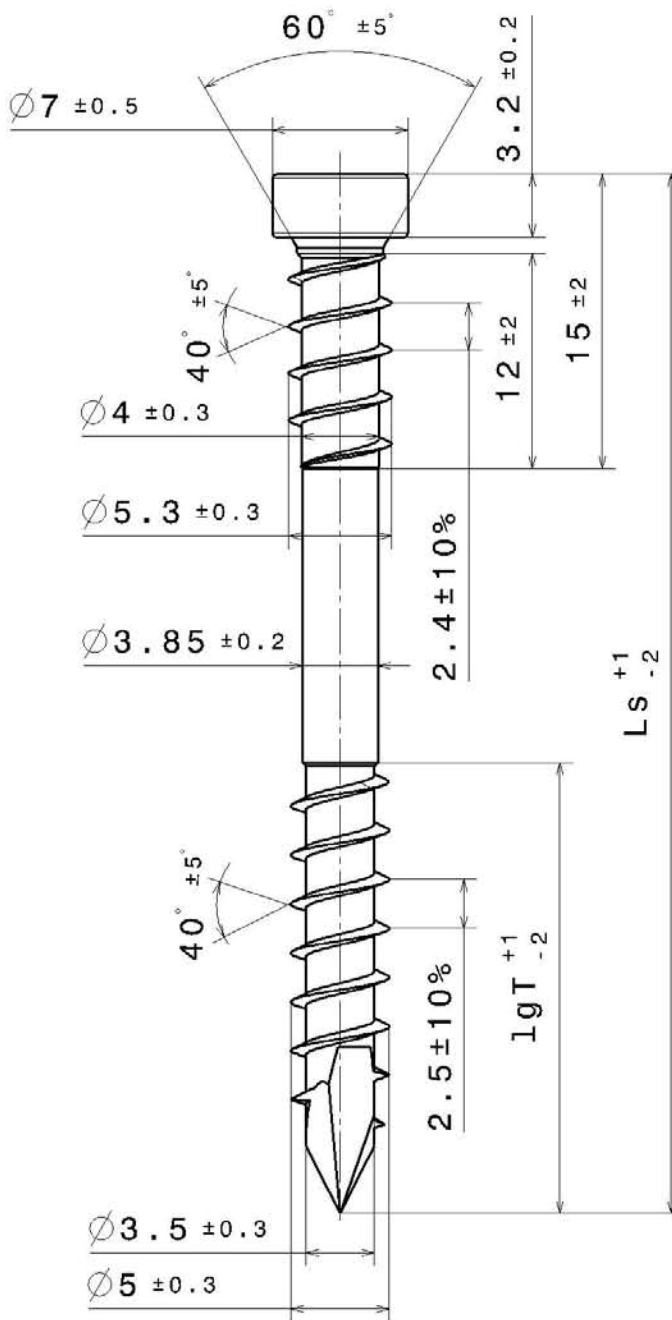

83	36
73	31
63	26
53	21
43	21
Ls	lgT*

*other thread lengths (lgT) are acceptable if $lgT > 4 \times \varnothing 5,0$

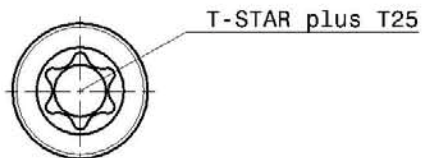

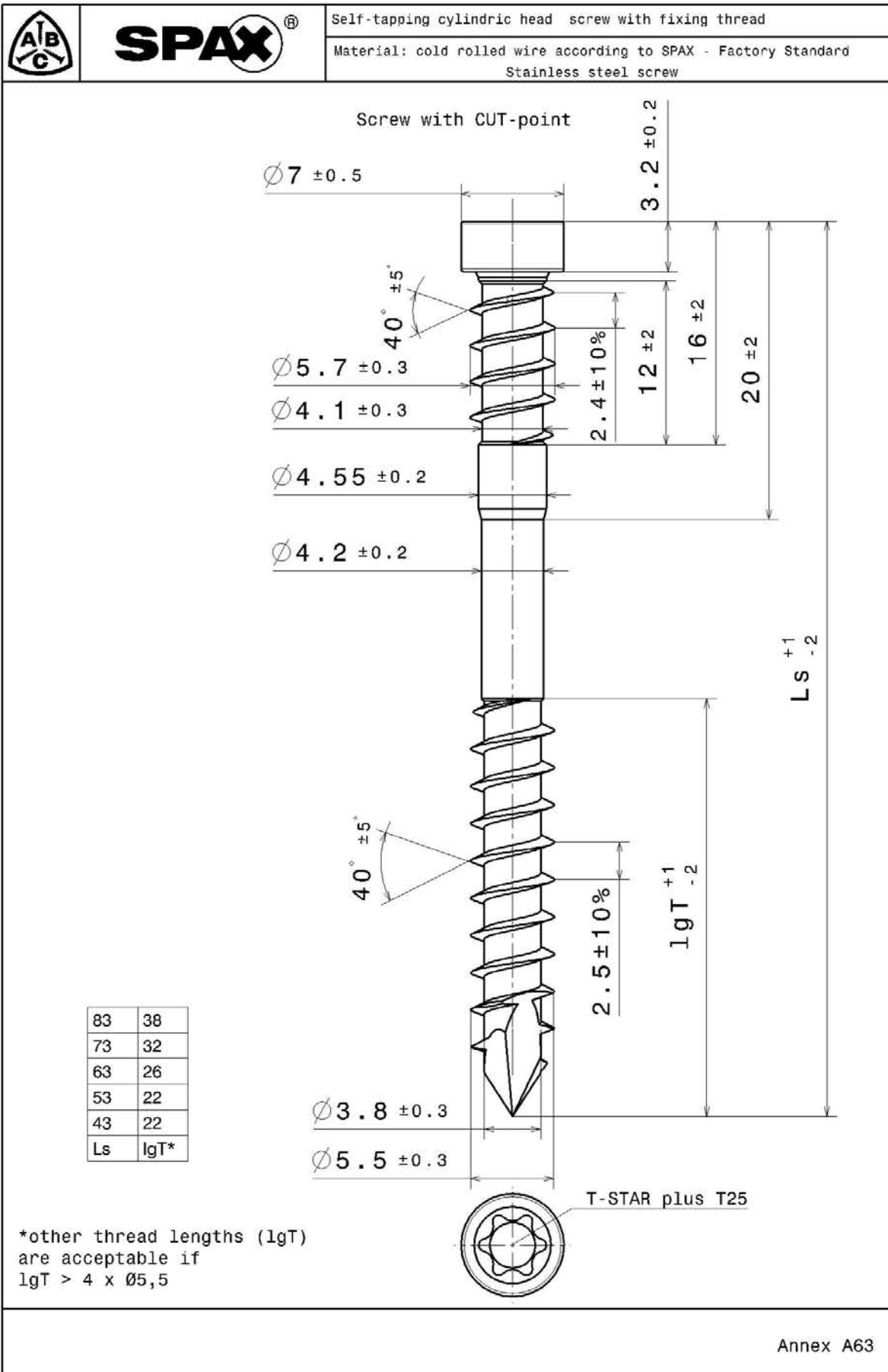

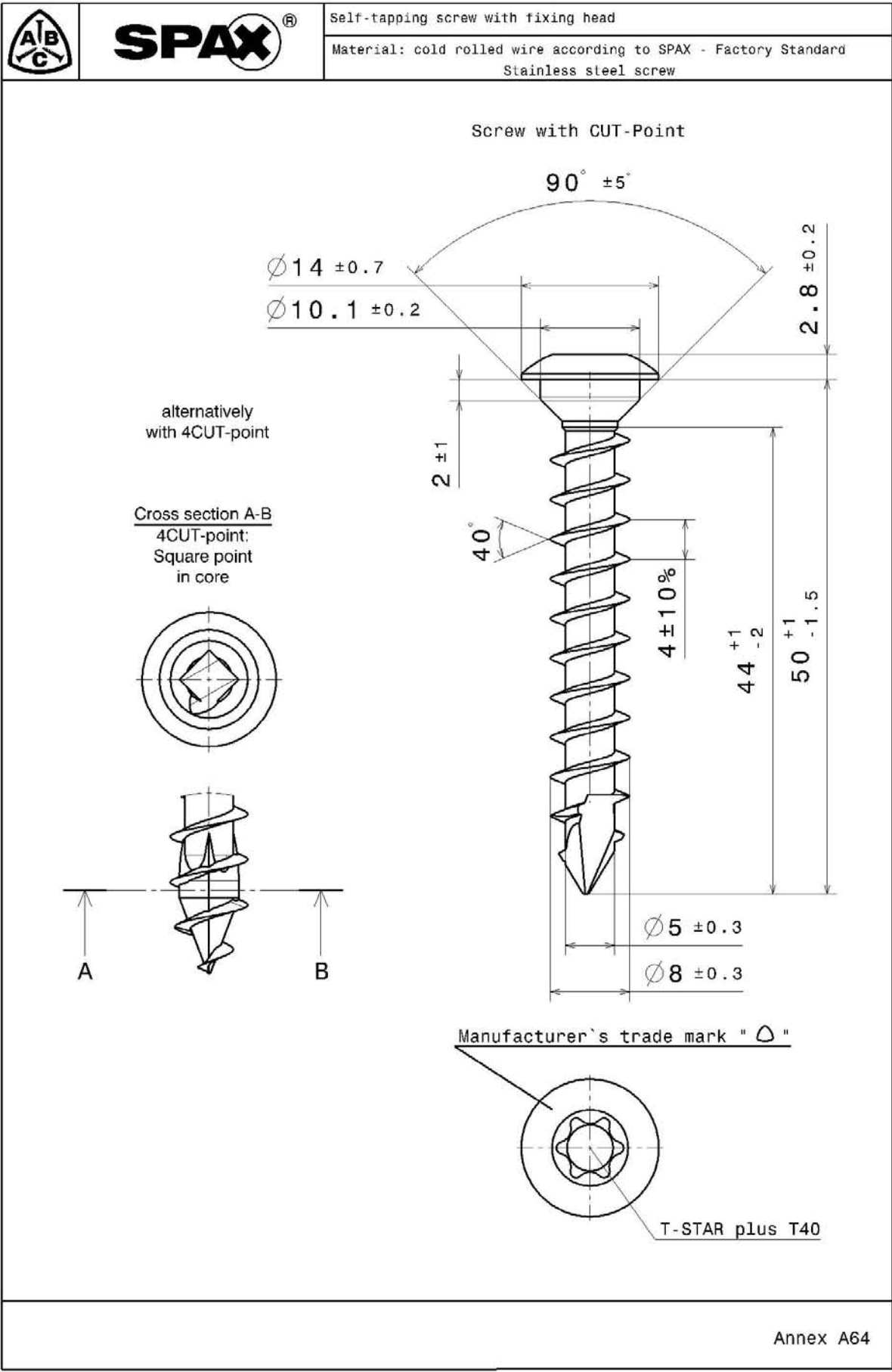

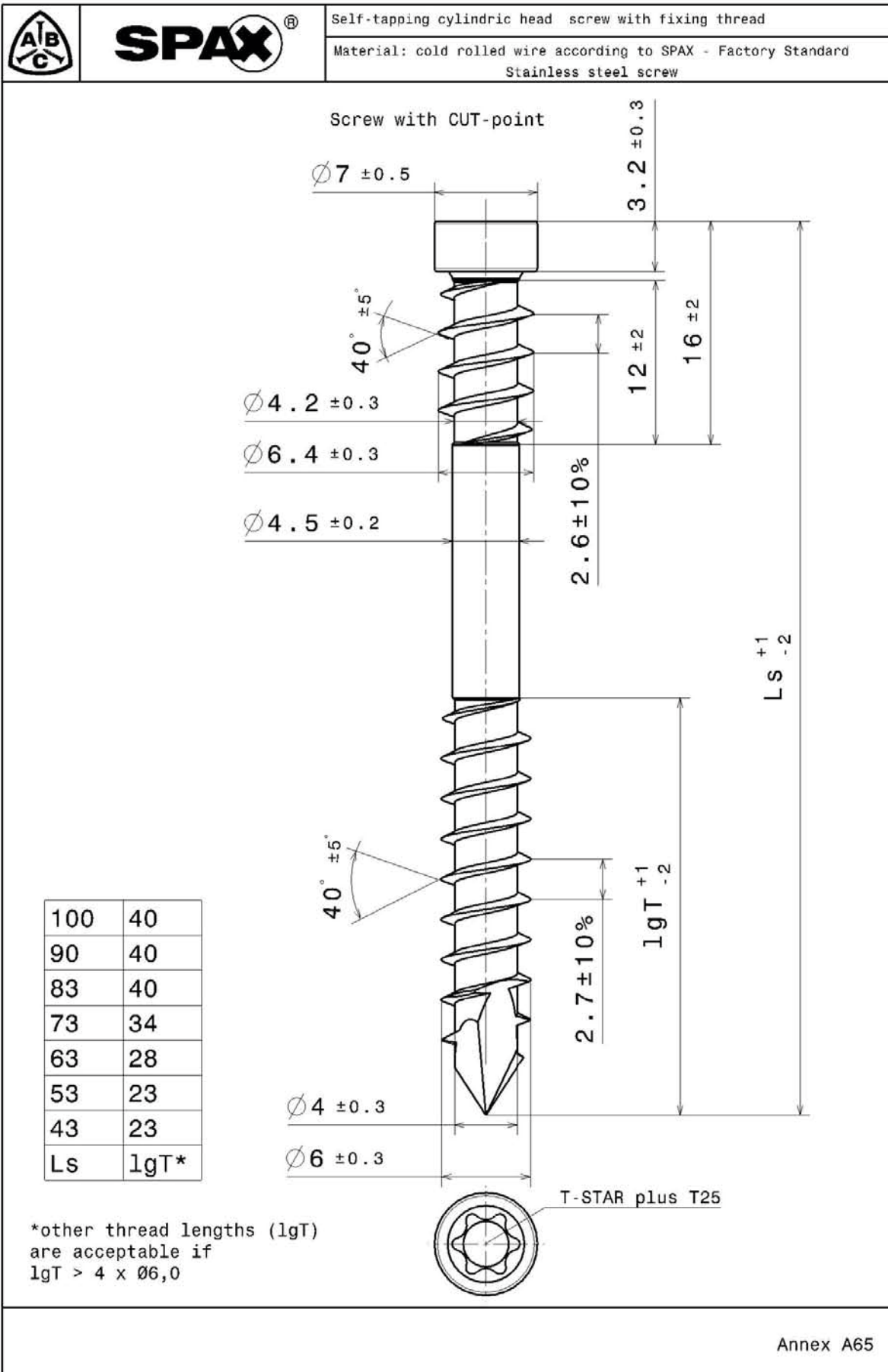

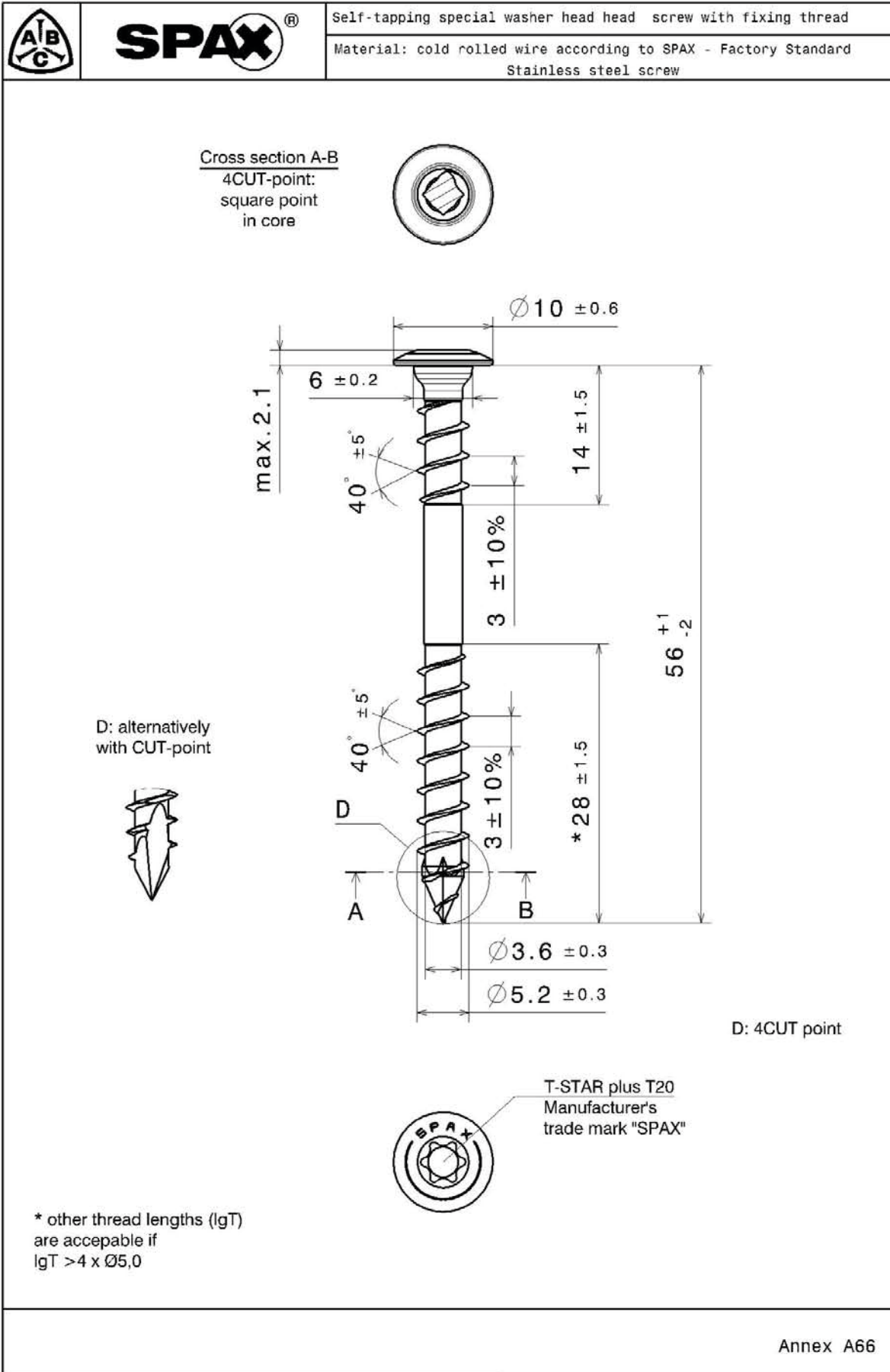





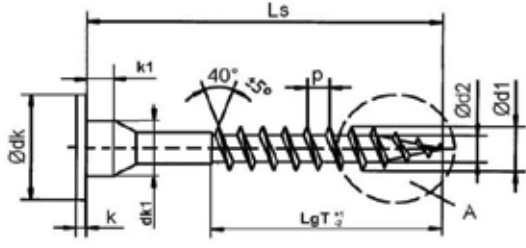

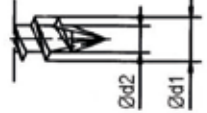

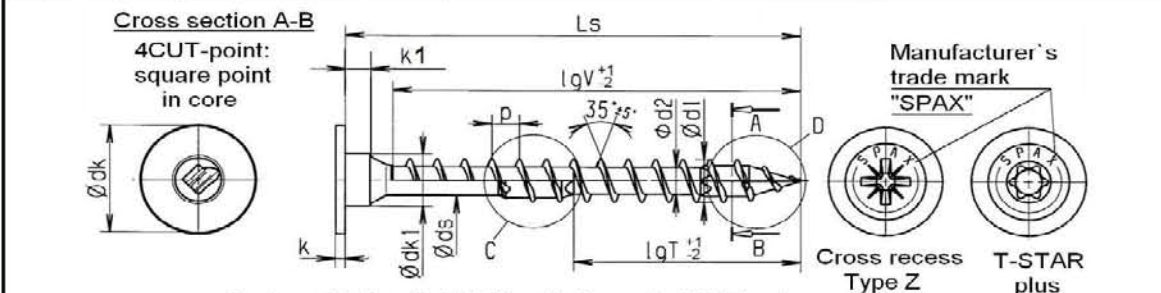

 SPAX® Special Washer head		Self-tapping screw with full and partial thread																					
		Material: cold rolled wire according to SPAX - Factory Standard Screws of high carbon steel																					
<p>C: alternatively with 4CUT-cutter* D: 4CUT-point</p>																							
Nominal diameter				4,5		5,0		6,0		8,0		10,0											
d1	thread size			4,5		5,0		6,0		8,1		10,0											
	permissible tolerance					±0,3				±0,4		±0,5											
dk	head diameter			10,6		8,8		11,6		9,7		13,6		11,6		20,0		15,1		25,0		18,6	
	permissible tolerance					±0,5				±0,65		±0,5		±1,0		±0,75		±1,25		±0,9			
dk1	diameter			6,3		6,3		7,5		8,8		13,5											
	permissible tolerance			±0,3						±0,4													
d2	core diameter			2,9		3,2		3,9		5,0		6,1											
	permissible tolerance							±0,3															
ds	shank diameter			3,20		3,55		4,30		5,70		6,80											
	permissible tolerance					±0,10				±0,25													
k	head height max.			1,5		1,5		2,0		2,5		3,0											
k1	head height			1,5		1,5		1,8		2,0		2,5											
	permissible tolerance					±0,3				±0,5													
p	thread pitch			2,7		3,0		3,6		4,8		6,0											
	permissible tolerance							±0,1 x p															
T-STAR plus size						T20		T30		T40		T50											
Cross recess size Type Z						2		3															
Ls		Standard thread lengths (full thread = lgV / partial thread = lgT)																					
Nom. dim.	min	max				lgV	lgT	lgV	lgT	lgV	lgT	lgV	lgT	lgV	lgT								
25	23,5	25,5				20,0		20,0															
30	28,5	30,5				25,0		25,0		24,0													
35	33,5	36,0				30,0		30,0		29,0													
40	38,5	41,0				34,0	20,0	35,0	20,0	34,0		32,0											
45	43,5	46,0				39,0	22,5	39,0	22,0	38,0		37,0											
50	48,5	51,0				44,0	25,0	44,0	25,0	43,0	24,0	42,0				40,0							
55	53,5	56,0				49,0	27,5	49,0	27,0	48,0	27,0	47,0				45,0							
60	58,5	61,0				54,0	30,0	54,0	30,0	53,0	29,0	52,0				50,0							
65	63,5	66,0				59,0	32,5	59,0	32,0	58,0	32,0	57,0	32,0	55,0									
70	68,5	71,0				59,0	34,0	61,0	35,0	61,0	34,0	61,0	32,0	60,0									
75	73,5	76,0				59,0	37,0	61,0	37,0	61,0	37,0	61,0	37,0	60,0									
80	78,5	81,0				59,0	39,0	61,0	39,0	61,0	38,0	70,0	39,0	70,0									
90	88,5	91,5				59,0	44,0		44,0	61,0	43,0	80,0	39,0	80,0									
100	98,5	101,5					49,0		49,0	61,0	48,0	80,0	47,0	80,0	50,0								
110	108,5	111,5					54,0		54,0	68,0*	53,0	80,0	47,0	80,0	50,0								
120	118,5	121,5							59,0	68,0*	56,0	80,0	57,0	80,0	60,0								
130	128,0	132,0								68,0*	61,0	80,0	61,0	80,0	60,0								
140	138,0	142,0									68,0*		70,0		70,0								
150	148,0	152,0									68,0*		70,0		70,0								
to																							
160	158,0	162,0									68,0*		80,0		80,0								
600	597,0	602,0											80,0		80,0								
Screws of Ø6,0mm with partial thread additionally in lengths of 180 to 300 mm, in steps of 20 mm, lgT = 68,0 mm*						Other thread lengths in the range ≥4xd1 to max. standard length permitted.																	
Intermediate lengths on Ls possible						* Design C with lgT = max. 65,0 mm																	
- Preferred size																							

			Self-tapping screw with partial thread		
	Special Washer Head		Material: Cold rolled wire according to SPAX - Factory Standard Screws of high-carbon steel		
			Manufacturer's trade mark or "SPAX" 		A: alternatively with CUT-point 
Nominal diameter			12,0		
Type of Head			Special Washer head		
d1	thread size	12,0			
	permissible tolerance	±0,30			
dk	head diameter	18,6	25,0	29,0	
	permissible tolerance	±0,93	±1,25	±1,45	
dk1	diameter	13,5			
	permissible tolerance	±0,6			
d2	core diameter	7,35			
	permissible tolerance	±0,35			
k	head height max.	4,0			
k1	head height	2,5			
	permissible tolerance	±0,5			
p	thread pitch	6,0			
	permissible tolerance	±0,1 x p			
T - STAR plus size		T50			
Ls		Standard thread lengths partial thread = lgT)			
Nom. dim.	min	max	lgT		
80	78,5	81,5	50,0		
90	88,5	91,5	55,0		
100	98,5	101,5	60,0		
110	108,5	111,5	80,0		
120	118,5	121,5	80,0		
130	128,0	132,0	80,0		
140	138,0	142,0	80,0		
150	148,0	152,0	100,0		
160	158,0	162,0	100,0		
180	178,0	182,0	100,0		
200	198,0	202,0	100,0		
to					
600	597,0	602,0	100,0		
Screw lengths Ls to 600 mm possible Other thread lengths in the range ≥4xd1 to max. standard length permitted					
Annex A68					

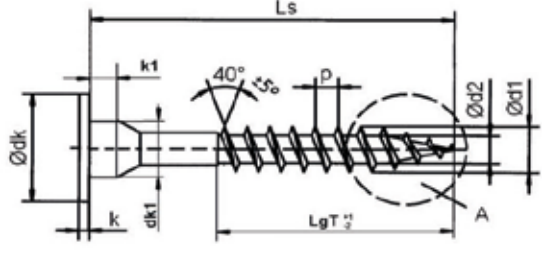
 SPAX® Special Washer head		Self-tapping screw with full and partial thread											
		Material: cold rolled wire according to SPAX - Factory Standard Stainless steel screw											
 <p>C: alternatively with 4CUT-cutter* D: 4CUT-point</p>													
Nominal diameter				4,5		5,0		6,0		8,0		10,0	
d1	thread size			4,5		5,0		6,0		8,1		10,0	
	permissible tolerance					±0,3				±0,4		±0,5	
dk	head diameter	10,6		8,8	11,6	9,7	13,6	11,6	20,0	15,1	25,0	18,6	
	permissible tolerance			±0,6				±0,65	±0,6	±1,0	±0,75	±1,25	±0,9
dk1	diameter	6,3		6,3		7,5		8,8		13,5			
	permissible tolerance			±0,5				±0,6					
d2	core diameter	3,1		3,4		3,9		5,3		6,1			
	permissible tolerance					±0,3							
ds	shank diameter	3,30		3,75		4,30		5,70		6,80			
	permissible tolerance			±0,3				±0,3					
k	head height max.	1,5		1,5		2,0		2,5		3,0			
k1	head height	1,5		1,5		1,8		2,0		2,5			
	permissible tolerance			±0,3				±0,5					
p	thread pitch	2,7		3,0		3,6		4,8		6,0			
	permissible tolerance					±0,1 x p							
T-STAR plus size				T20		T30		T40		T50			
Cross recess size Type Z				2		3							
Ls		Standard thread lengths (full thread = lgV / partial thread = lgT)											
Nom. dim.	min	max	lgV	lgT	lgV	lgT	lgV	lgT	lgV	lgT	lgV	lgT	
25	23,5	25,5	20,0		20,0								
30	28,5	30,5	25,0		25,0		24,0						
35	33,5	36,0	30,0		30,0		29,0						
40	38,5	41,0	34,0	20,0	35,0	20,0	34,0		32,0				
45	43,5	46,0	39,0	22,5	39,0	22,0	38,0		37,0				
50	48,5	51,0	44,0	25,0	44,0	25,0	43,0	24,0	42,0			40,0	
55	53,5	56,0	49,0	27,5	49,0	27,0	48,0	27,0	47,0			45,0	
60	58,5	61,0	54,0	30,0	54,0	30,0	53,0	29,0	52,0			50,0	
65	63,5	66,0	59,0	32,5	59,0	32,0	58,0	32,0	57,0	32,0		55,0	
70	68,5	71,0	59,0	34,0	61,0	35,0	61,0	34,0	61,0	32,0		60,0	
75	73,5	76,0	59,0	37,0	61,0	37,0	61,0	37,0	61,0	37,0		60,0	
80	78,5	81,0	59,0	39,0	61,0	39,0	61,0	38,0	70,0	39,0		70,0	
90	88,5	91,5	59,0	44,0		44,0	61,0	43,0	80,0	39,0		80,0	
100	98,5	101,5		49,0		49,0	61,0	48,0	80,0	47,0		80,0	50,0
110	108,5	111,5		54,0		54,0	68,0*	53,0	80,0	47,0		80,0	50,0
120	118,5	121,5				59,0	68,0*	56,0	80,0	57,0		80,0	60,0
130	128,0	132,0					68,0*	61,0	80,0	61,0		80,0	60,0
140	138,0	142,0						68,0*		70,0		70,0	
150	148,0	152,0						68,0*		70,0		70,0	
to													
160	158,0	162,0						68,0*		80,0		80,0	
600	597,0	602,0								80,0		80,0	
Screws of Ø6,0mm with partial thread additionally in lengths of 180 to 300 mm, in steps of 20 mm, LgT= 68,0 mm*						Other thread lengths in the range ≥4xd1 to max. standard length permitted.							
Intermediate lengths on Ls possible						* Design C with lgT= max. 65,0 mm							
=Preferred size													

	 Special Washer Head	Self-tapping screw with partial thread Material: Cold rolled wire according to SPAX - Factory Standard Stainless steel screw	
			Manufacturer's trade mark or "SPAX"  T-STAR plus or T-STAR
Nominal diameter		12,0	
Type of Head		Special Washer head	
d1	thread size	12,0	
	permissible tolerance	±0,60	
dk	head diameter	18,6	25,0
	permissible tolerance	±0,93	±1,25
dk1	diameter	13,5	
	permissible tolerance	±0,6	
d2	core diameter	7,35	
	permissible tolerance	±0,35	
k	head height max.	4,0	
k1	head height	2,5	
	permissible tolerance	±0,5	
p	thread pitch	6,0	
	permissible tolerance	±0,1 x p	
T - STAR plus size		T50	
Ls		Standard thread lengths partial thread = lgT)	
Nom. dim.	min	max	lgT
80	78,5	81,5	50,0
90	88,5	91,5	55,0
100	98,5	101,5	60,0
110	108,5	111,5	80,0
120	118,5	121,5	80,0
130	128,0	132,0	80,0
140	138,0	142,0	80,0
150	148,0	152,0	100,0
160	158,0	162,0	100,0
180	178,0	182,0	100,0
200	198,0	202,0	100,0
<i>to</i>			
600	597,0	602,0	100,0
Screw lengths Ls to 600 mm possible Other thread lengths in the range ≥4xd1 to max. standard length permitted			
Annex A70			

Anhang B Mindestabstände

Mindestabstände für ausschließlich axial belastete SPAX Schrauben mit CUT-Spitze oder 4CUT in der Spitze oder mit $d \leq 8$ mm in nicht vorgebohrten Löchern in Bauteilen aus Vollholz, Brettschichtholz oder ähnlich verleimten Produkten

Einsinnige Anordnung

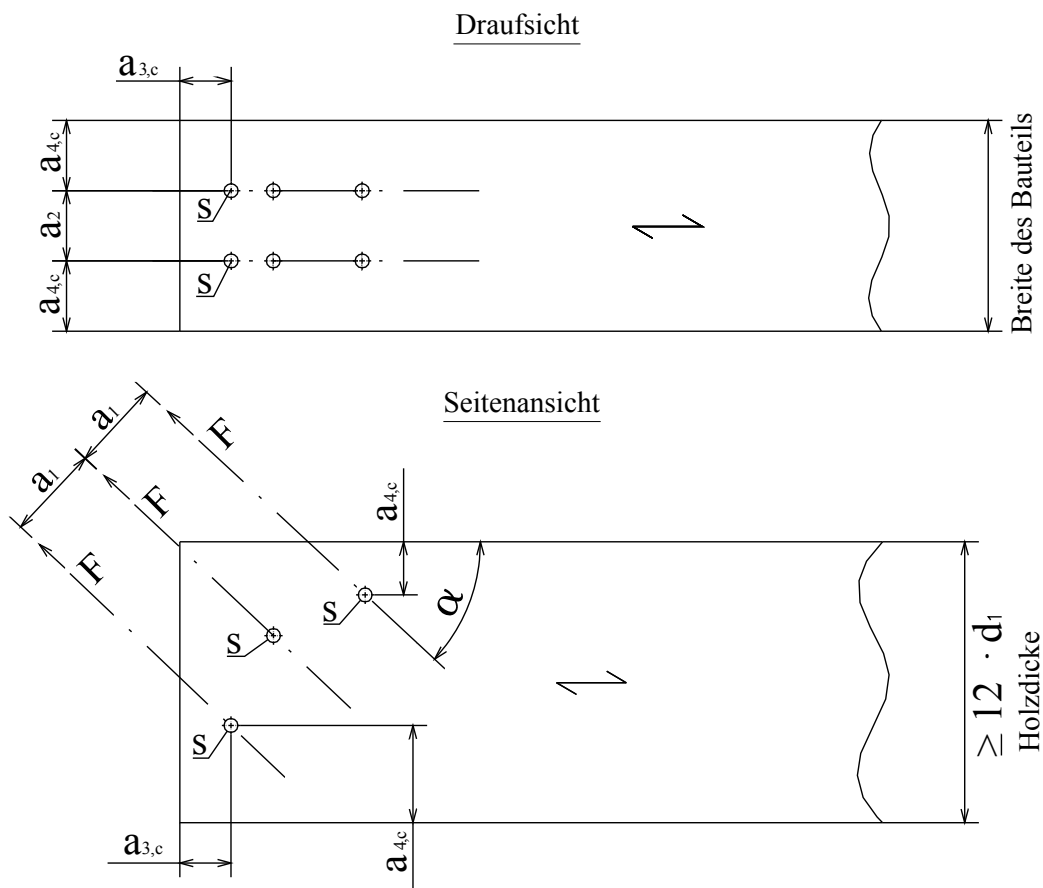

- \longleftarrow Faserrichtung
- - - Schraubenachse
- S Schwerpunkt des Schraubenteils im Holz
- $15^\circ \leq \alpha \leq 90^\circ$

$$\begin{aligned}
 a_1 &\geq 5 \cdot d \\
 a_2 &\geq 2,5 \cdot d \\
 a_{3,c} &\geq 5 \cdot d \\
 a_{4,c} &\geq 4 \cdot d \\
 &\geq 3 \cdot d \quad \text{für Schrauben mit CUT-Spitze oder 4CUT in der Spitze} \\
 a_1 \cdot a_2 &\geq 25 \cdot d^2
 \end{aligned}$$

Mindestabstände siehe auch 3.11

Mindestholzdicke $t = 12 \cdot d$ für Vollholz oder Brettschichtholz und $t = 6 \cdot d$ für Furnierschichtholz, siehe auch 3.11

Mindestabstände für ausschließlich axial belastete SPAX Schrauben mit CUT-Spitze oder 4CUT in der Spitze oder mit $d \leq 8$ mm in nicht vorgebohrten Löchern in Bauteilen aus Vollholz, Brettschichtholz oder ähnlich verleimten Produkten

Kreuzweise Anordnung

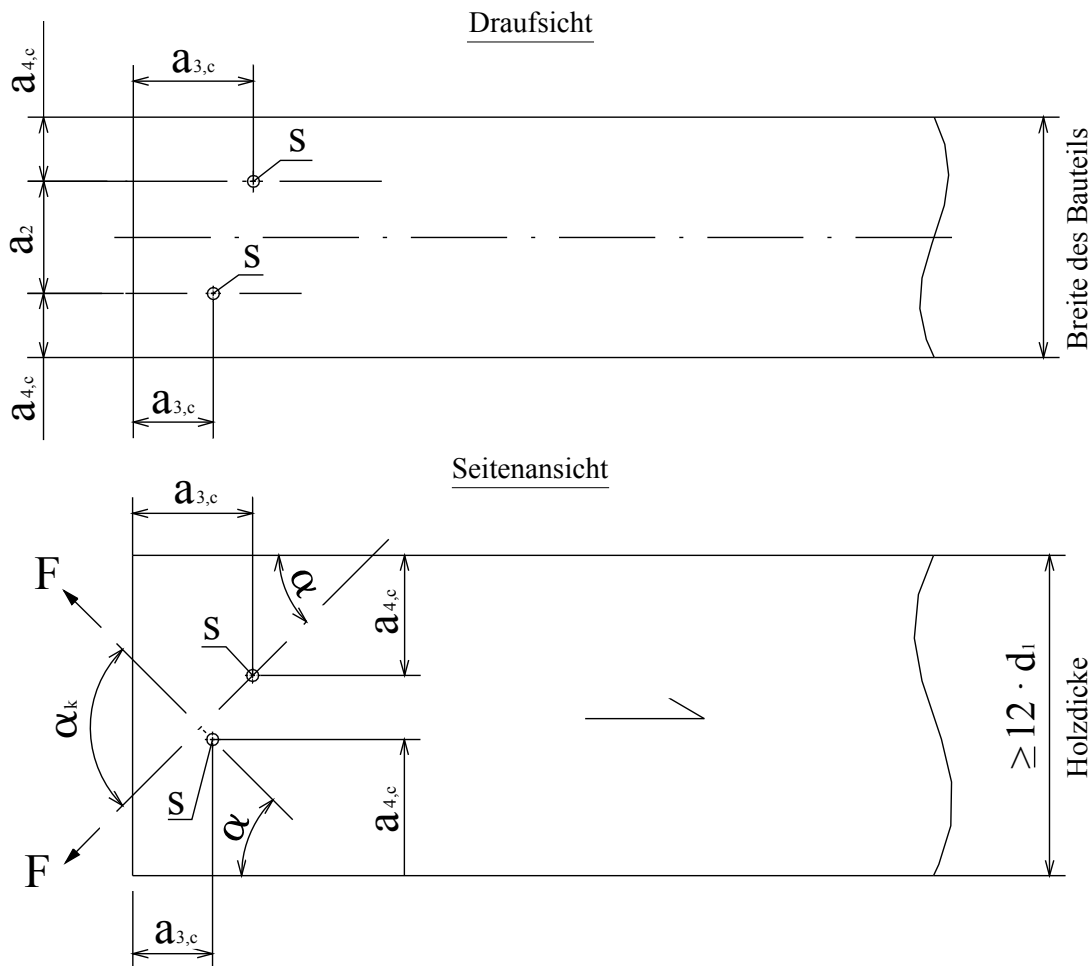

- Faserrichtung
- - - Schraubenachse
- S Schwerpunkt des Schraubenteils im Holz
- $15^\circ \leq \alpha \leq 90^\circ$

$$\begin{aligned}
 a_1 &\geq 5 \cdot d \\
 a_2 &\geq 1,5 \cdot d && \text{für } 70^\circ < \alpha_k \leq 90^\circ \\
 &\geq 2,5 \cdot d \cdot (1 - \alpha_k / 180^\circ) && \text{für } 30^\circ \leq \alpha_k \leq 70^\circ \\
 a_{3,c} &\geq 5 \cdot d \\
 a_{4,c} &\geq 4 \cdot d \\
 &\geq 3 \cdot d && \text{für Schrauben mit CUT-Spitze oder 4CUT in der Spitze} \\
 a_1 \cdot a_2 &\geq 25 \cdot d^2
 \end{aligned}$$

Mindestabstände siehe auch 3.11

Mindestholzdicke $t = 12 \cdot d$ für Vollholz oder Brettschichtholz und $t = 6 \cdot d$ für Furnierschichtholz, siehe auch 3.11

Nachgiebig verbundene Biegeträger

SPAX Schrauben mit Vollgewinde oder Gewindestangen können zur Verbindung von Bauteilen in mechanisch verbundenen Biegeträger oder Stützen verwendet werden, die aus mehreren Teilen bestehen.

Das axiale Verschiebungsmodul K_{ser} einer Schraube oder Gewindestange mit Vollgewinde für den Grenzzustand der Gebrauchstauglichkeit in Richtung der Schraubenachse beträgt unabhängig vom Winkel α zur Faser:

$$C = K_{ser} = 25 \cdot d \cdot \ell_{ef} \text{ [N/mm]} \text{ für Schrauben oder Gewindestangen in Nadelholz}$$

$$C = K_{ser} = 30 \cdot d \cdot \ell_{ef} \text{ [N/mm]} \text{ für Schrauben in vorgebohrtem Laubholz}$$

Dabei ist

d der Gewindeaußendurchmesser [mm]

ℓ_{ef} die Eindringtiefe in das Bauteil [mm], $\ell_{ef} = \ell_1$ oder ℓ_2

Axial belastete SPAX Schrauben oder Gewindestangen in Vollholz, Brettschichtholz oder Furnierschichtholz

Einsinnige Anordnung

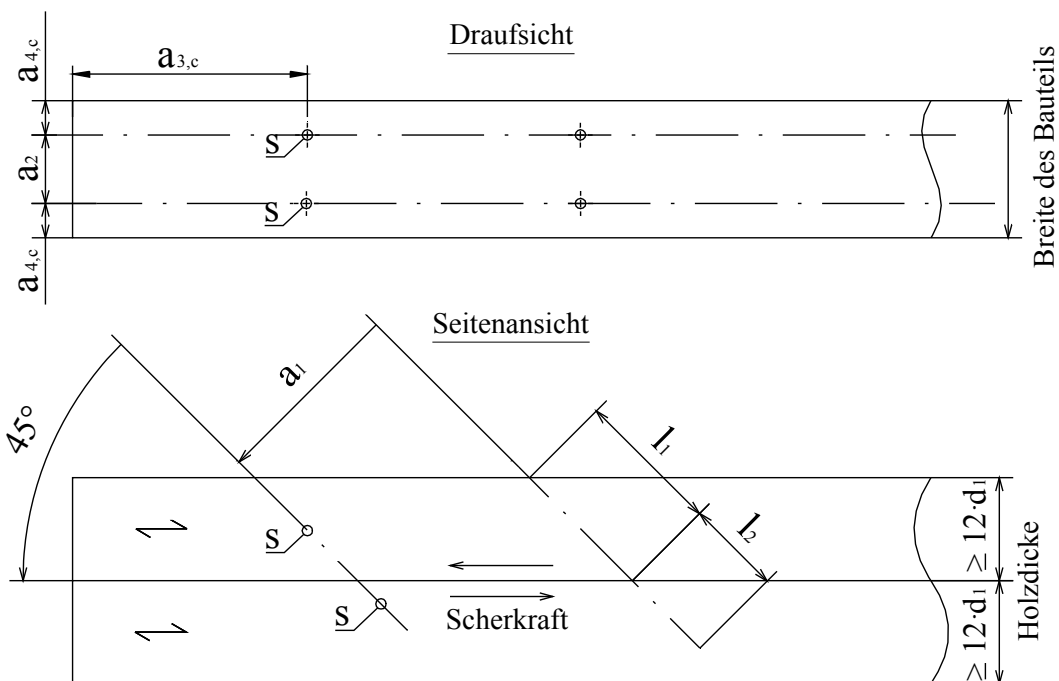

- \rightarrow Faserrichtung
- - - Schraubenachse
- S Schwerpunkt des Schraubenteils im Holz

$$\begin{aligned}
 a_1 &\geq 5 \cdot d \\
 a_2 &\geq 2,5 \cdot d \\
 a_{3,c} &\geq 5 \cdot d \\
 a_{4,c} &\geq 4 \cdot d \\
 &\geq 3 \cdot d \quad \text{für Schrauben mit CUT-Spitze oder 4CUT in der Spitze} \\
 a_1 \cdot a_2 &\geq 25 \cdot d^2
 \end{aligned}$$

Mindestabstände siehe auch 3.11

Mindestholzdicke $t = 12 \cdot d$ für Vollholz oder Brettschichtholz und $t = 6 \cdot d$ für Furnierschichtholz, siehe auch 3.11

Axial belastete SPAX Schrauben oder Gewindestangen in Vollholz, Brettschichtholz oder Furnierschichtholz

Kreuzweise Anordnung

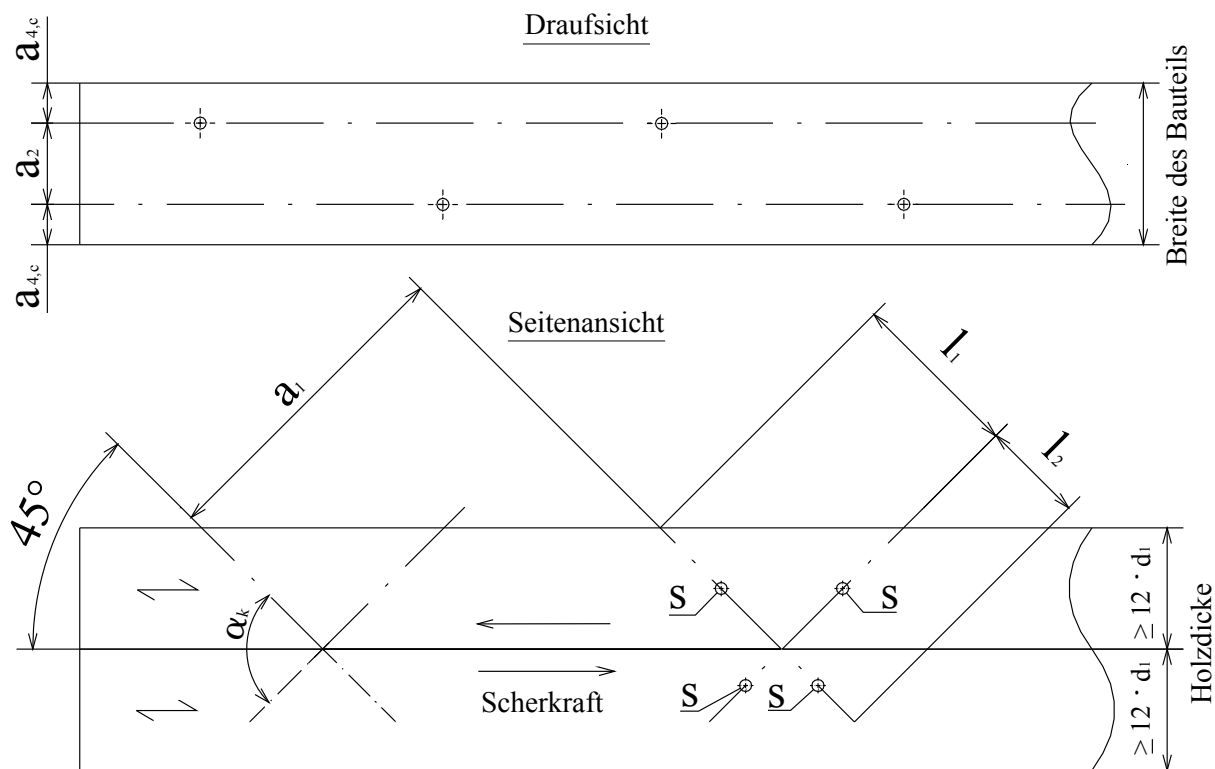

- \longleftrightarrow Faserrichtung
- - - Schraubenachse
- S Schwerpunkt des Schraubenteils im Holz

- $a_1 \geq 5 \cdot d$
- $a_2 \geq 2,5 \cdot d$ ($a_2 \geq 1,5 \cdot d$ im Kreuzungspunkt sich kreuzende Schrauben)
- $a_{3,c} \geq 5 \cdot d$
- $a_{4,c} \geq 4 \cdot d$
- $\geq 3 \cdot d$ für Schrauben mit CUT-Spitze oder 4CUT in der Spitze
- $a_1 \cdot a_2 \geq 25 \cdot d^2$

Mindestabstände siehe auch 3.11

Mindestholzdicke $t = 12 \cdot d$ für Vollholz oder Brettschichtholz und $t = 6 \cdot d$ für Furnierschichtholz, siehe auch 3.11

Schrauben unter Axial- oder Querbelastung in der Deckfläche oder Schmalfäche von Brettsperrholz

Definition von End- und Randabständen sowie der Abstände untereinander in der Deckfläche, sofern in der technischen Spezifikation (ETA oder hEN) für das Brettsperrholz nicht anders angegeben:

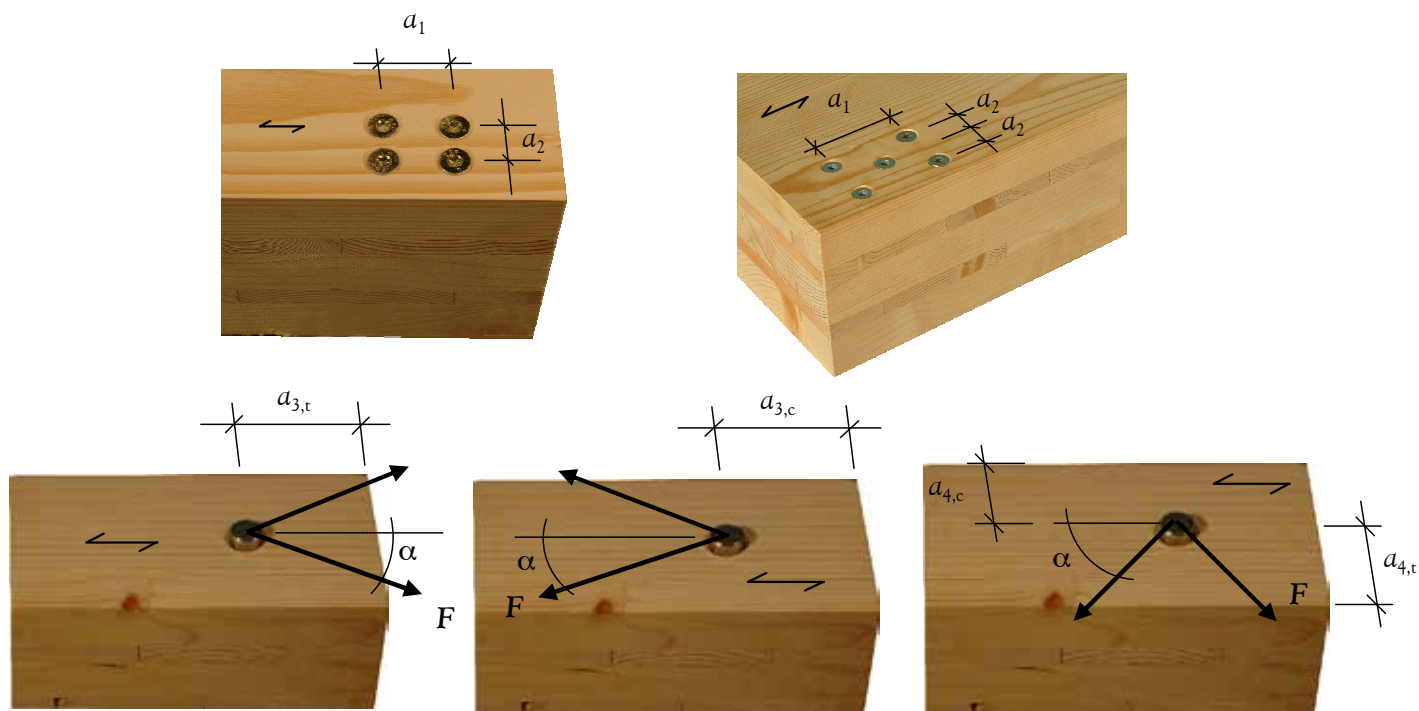

Definition von End- und Randabständen sowie der Abstände untereinander in der Schmalfäche, sofern in der technischen Spezifikation (ETA oder hEN) für das Brettsperrholz nicht anders angegeben:

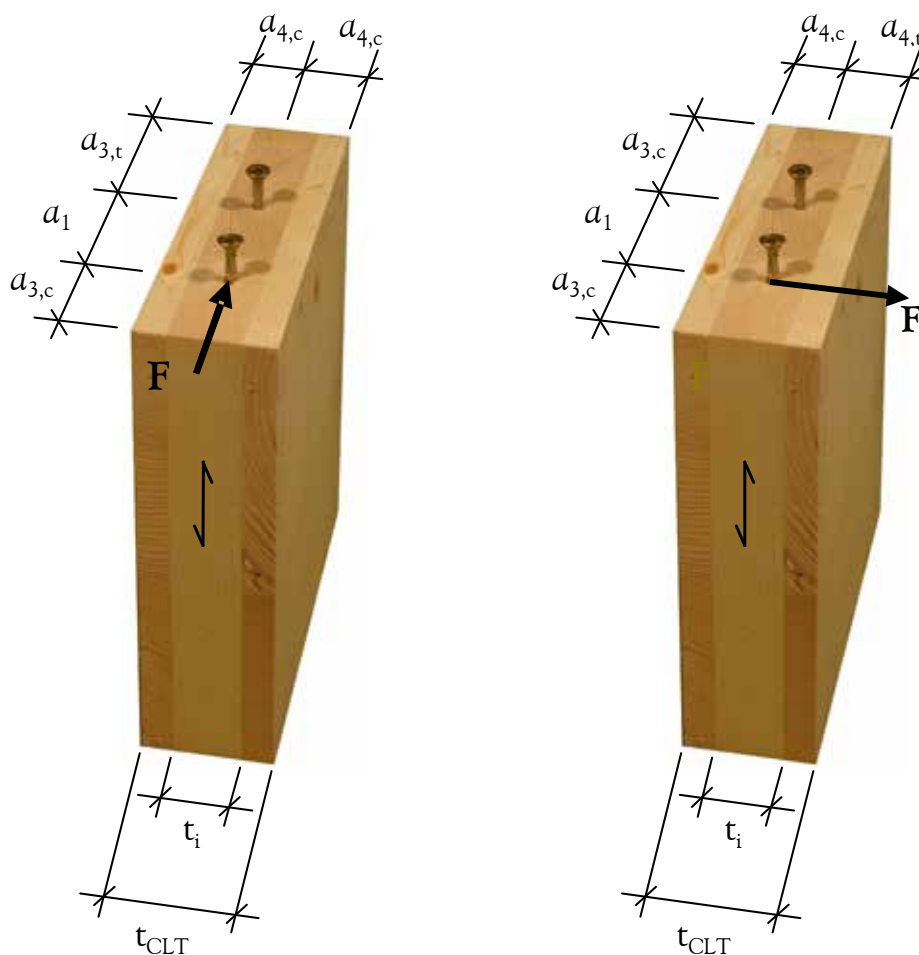

Anhang C

Verstärkung von querdruckbeanspruchten Holzbauteilen

SPAX Schrauben oder Gewindestangen mit Vollgewinde können für die Verstärkung von Holzbauteilen unter Druckbeanspruchung in einem Winkel α zur Faser von $45^\circ \leq \alpha \leq 90^\circ$ verwendet werden.

Die Druckkraft muss gleichmäßig auf alle Schrauben verteilt werden. Als Zwischenschicht zwischen Holzbauteil und Untergrund muss eine geeignete Stahlplatte montiert werden. Die Schrauben müssen bündig in das Holzbauteil geschraubt werden, um sowohl einen direkten Kontakt zur Stahlplatte als auch den direkten Kontakt zwischen Stahlplatte und Holzbauteil zu gewährleisten.

Der charakteristische Wert der Tragfähigkeit für eine Kontaktfläche mit Schrauben mit Vollgewinde unter einem Winkel α zur Faser von $45^\circ \leq \alpha \leq 90^\circ$ ist wie folgt zu berechnen:

$$F_{90,Rd} = \min \left\{ \begin{array}{l} k_{c,90} \cdot B \cdot \ell_{ef,1} \cdot f_{c,90,d} + n \cdot F_{ax,Rd} \\ B \cdot \ell_{ef,2} \cdot f_{c,90,d} \end{array} \right. \quad (C.1)$$

Dabei ist

- $F_{90,Rd}$ der Bemessungswert der Tragfähigkeit der verstärkten Kontaktfläche [N]
- $k_{c,90}$ der Druckbeiwert senkrecht zur Faserrichtung gemäß EN 1995-1-1
- B die Auflagerbreite [mm]
- $\ell_{ef,1}$ die wirksame Auflagerlänge gemäß EN 1995-1-1 [mm]
- $f_{c,90,d}$ der Bemessungswert der Druckfestigkeit senkrecht zur Faserrichtung [N/mm²]
- n die Anzahl der Verstärkungsschrauben, $n = n_0 \cdot n_{90}$
- n_0 die Anzahl der Verstärkungsschrauben in einer Reihe parallel zur Faserrichtung
- n_{90} die Anzahl der Verstärkungsschrauben in einer Reihe senkrecht zur Faserrichtung
- $F_{ax,Rd}$ der Bemessungswert der Drucktragfähigkeit [N], siehe Seite 7
- $\ell_{ef,2}$ die effektive Auflagerlänge in der Ebene der Schraubenspitze [mm]
- $\ell_{ef,2} = \ell_{ef} + (n_0 - 1) \cdot a_1 + \min(\ell_{ef}, a_{3,c})$ für Endlager [mm]
- $\ell_{ef,2} = 2 \cdot \ell_{ef} + (n_0 - 1) \cdot a_1$ für Mittellager [mm]
- ℓ_{ef} spitzenseitige Einschraubtiefe [mm]
- a_1 der Abstand parallel zur Faserrichtung [mm]
- $a_{3,c}$ Randabstand zum Hirnholzende [mm]

Wenn Schrauben von oben und unten in das Holzbauteil geschraubt werden und die Schrauben mindestens $10 \cdot d$, i.e. $\ell_{ef,top} + \ell_{ef,bottom} \geq H + 10 \cdot d$ überlappen, kann die zweite Bedingung der Gleichung (C.1) außer Acht gelassen werden.

Verstärkungsschrauben oder -gewindestangen für Holzwerkstoffplatten fallen nicht in den Geltungsbereich dieser Europäischen Technischen Bewertung.

Verstärktes Mittellauger

- H die Höhe des Bauteils [mm]
- B die Auflagerbreite [mm]
- l_{ef} spitzenseitige Einschraubtiefe [mm]
- $l_{ef,2}$ die effektive Auflagerlänge in der Ebene der Schraubenspitze [mm]
- $= 2 \cdot l_{ef} + (n_0 - 1) \cdot a_1$ für Mittellauger

Faserrichtung
 Schraubenachse
 $45^\circ \leq \alpha \leq 90^\circ$

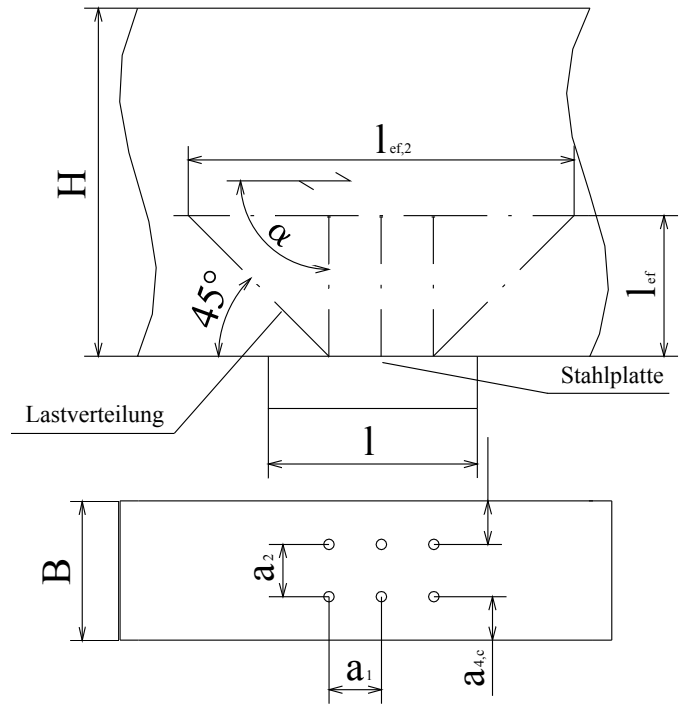

Verstärktes Endlager

- H die Höhe des Bauteils [mm]
- B die Auflagerbreite [mm]
- l_{ef} spitzenseitige Einschraubtiefe [mm]
- $l_{ef,2}$ die effektive Auflagerlänge in der Ebene der Schraubenspitze [mm]
- $= l_{ef} + (n_0 - 1) \cdot a_1 + \min(l_{ef}; a_{3,c})$ für Endlager

Faserrichtung
 Schraubenachse
 $45^\circ \leq \alpha \leq 90^\circ$

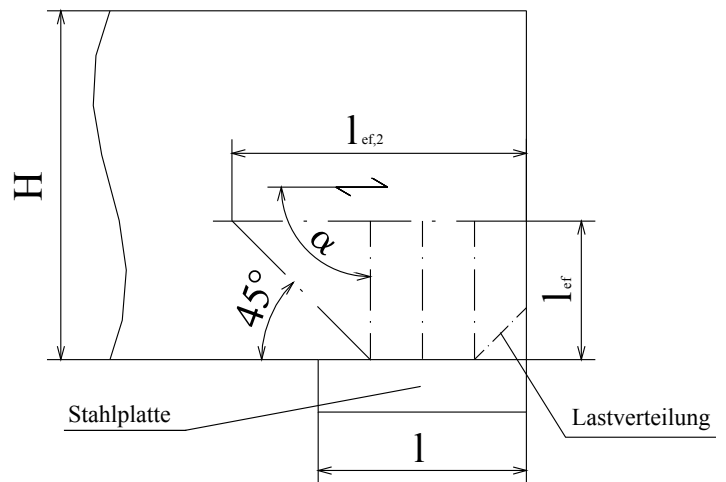

- $a_1 \geq 5 \cdot d$
- $a_2 \geq 2,5 \cdot d$
- $a_{3,c} \geq 5 \cdot d$
- $a_{4,c} \geq 4 \cdot d$
- $\geq 3 \cdot d$ für Schrauben mit CUT-Spitze oder 4CUT in der Spitze
- $a_1 \cdot a_2 \geq 25 \cdot d^2$

Der Schraubenkopf muss bündig mit der Oberfläche des Anbauteils abschließen.

Anhang D Verstärkung von querzugbeanspruchten Holzbauteilen

Sofern in den für den Installationsort geltenden nationalen Bestimmungen nicht anders definiert, muss die axiale Tragfähigkeit der Verstärkung eines Holzbauteils, das unter der Belastung einer Verbindungskraft quer zur Faserrichtung steht, die folgende Bedingung erfüllen:

$$\frac{[1 - 3 \cdot \alpha^2 + 2 \cdot \alpha^3] \cdot F_{90,d}}{F_{ax,Rd}} \leq 1$$

Dabei ist

$F_{90,d}$ Bemessungswert der Kraftkomponente quer zur Faserrichtung [N],

$\alpha = a/h$

h Bauteilhöhe [mm]

$F_{ax,Rd}$ Minimum der Bemessungswerte der Ausziehtragfähigkeit und der Zugtragfähigkeit der Verstärkungsschrauben oder -gewindestangen, wobei ℓ_{ef} der kleinere Wert der Eindringtiefe unter oder über dem potenziellen Riss ist. [N]

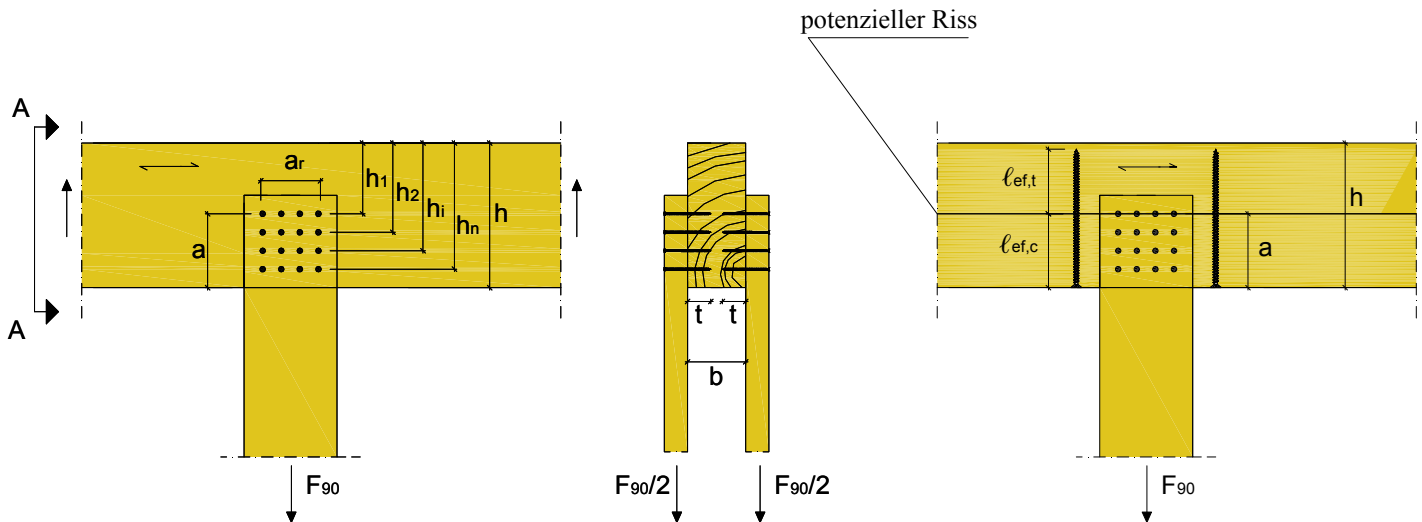

Sofern in den für den Installationsort geltenden nationalen Bestimmungen nicht anders definiert, muss die axiale Tragfähigkeit der Verstärkung eines ausgeklinkten Trägers die folgende Bedingung erfüllen:

$$\frac{1,3 \cdot V_d \cdot [3 \cdot (1 - \alpha)^2 - 2 \cdot (1 - \alpha)^3]}{F_{ax,Rd}} \leq 1$$

Dabei ist

V_d Bemessungswert der Auflagerkraft [N],

$\alpha = h_c/h$

h Bauteilhöhe [mm]

$F_{ax,Rd}$ Minimum der Bemessungswerte der Ausziehtragfähigkeit und der Zugtragfähigkeit der Verstärkungsschrauben oder -gewindestangen, wobei ℓ_{ef} der kleinere Wert der Eindringtiefe unter oder über dem potenziellen Riss ist. [N]

Der Mindestabstand a_2 von Gewindestangen als Verstärkung eines ausgeklinkten Trägers beträgt $a_2 = 3 \cdot d$, der Mindestabstand zum Rand beträgt $a_{3,c} = 2,5 \cdot d$ oder $a_{4,c} = 2,5 \cdot d$.

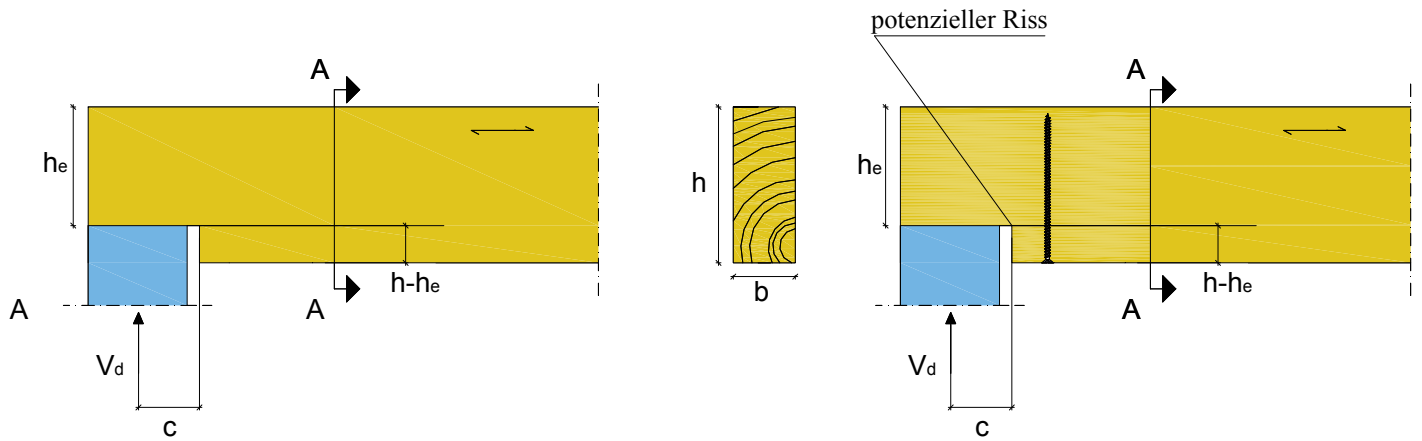

Sofern in den für den Installationsort geltenden nationalen Bestimmungen nicht anders definiert, muss die axiale Tragfähigkeit der Verstärkung eines Trägerlochs die folgende Bedingung erfüllen:

$$\frac{F_{t,V,d} + F_{t,M,d}}{F_{ax,Rd}} \leq 1$$

Dabei ist

$F_{t,V,d}$ Bemessungswert der Zugkraft senkrecht zur Faserrichtung aufgrund der Scherkraft [N]:

$$F_{t,V,d} = \frac{V_d \cdot h_d}{4 \cdot h} \cdot \left[3 - \frac{h_d^2}{h^2} \right]$$

V_d der Bemessungswert der Schwerkraft des Bauteils am Lochende [N],

h Bauteilhöhe [mm]

h_d Lochtiefe für rechteckige Löcher [mm]

h_d 70 % des Lochdurchmessers für runde Löcher [mm]

$F_{t,M,d}$ Bemessungswert der Zugkraft quer zur Faserrichtung aufgrund des Biegemoments [N]:

$$F_{t,M,d} = 0,008 \cdot \frac{M_d}{h_r}$$

M_d Bemessungswert des Biegemoments des Bauteils am Lochende [Nm],

$h_r = \min(h_{ro}; h_{ru})$ für rechteckige Löcher [mm]

$h_r = \min(h_{ro}; h_{ru}) + 0,15 \cdot h_d$ für runde Löcher [mm]

$F_{ax,Rd}$ Minimum der Bemessungswerte des Ausziehtragfähigkeit und der Zugtragfähigkeit der Verstärkungsschrauben oder -gewindestangen, wobei l_{ef} der kleinere Wert der Eindringtiefe unter oder über dem potenziellen Riss ist. [N]

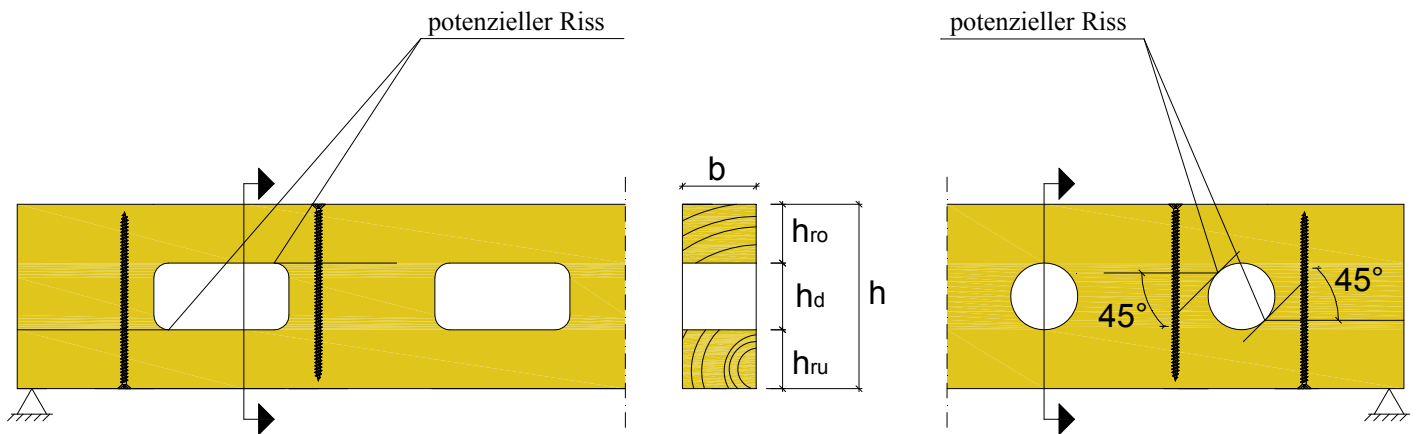

Es muss darauf hingewiesen werden, dass neben der Schraubenverstärkung auch eine Überprüfung der Scherkraft des Bauteils rund um das Loch erforderlich ist.

Anhang E Schubverstärkung

Sofern in den für den Installationsort geltenden nationalen Bestimmungen nicht anders definiert, muss die Scherkraft an den bewehrten Bereichen des Holzbauteils mit Belastung parallel zur Faserrichtung die folgende Bedingung erfüllen:

$$\tau_d \leq \frac{f_{v,d} \cdot k_\tau}{\eta_H}$$

Dabei ist:

τ_d der Bemessungswert der Schubspannung unabhängig von der Bewehrung [N/mm²];

$f_{v,d}$ der Bemessungswert der Schubfestigkeit [N/mm²];

$k_\tau = 1 - 0,46 \cdot \sigma_{90,d} - 0,052 \cdot \sigma_{90,d}^2$

$\sigma_{90,d}$ der Bemessungswert der Belastung quer zur Faserrichtung (negativer Wert für Druck) [N/mm²];

$$\sigma_{90,d} = \frac{F_{ax,d}}{\sqrt{2} \cdot b \cdot a_1}$$

$$F_{ax,d} = \frac{\sqrt{2} \cdot (1 - \eta_H) \cdot V_d \cdot a_1}{h} \quad [\text{N}]$$

$$\eta_H = \frac{G \cdot b}{G \cdot b + \frac{1}{2 \cdot \sqrt{2} \left(\frac{6}{\pi \cdot d \cdot h \cdot k_{ax}} + \frac{a_1}{EA_s} \right)}}$$

V_d der Bemessungswert der Schubkraft [N];

G das Schubmodul des Holzbauteils, $G = 650$ [N/mm²],

b die Breite des Holzbauteils [mm],

d der Gewindeaußendurchmesser [mm] (d_1 in den Zeichnungen im Anhang)

h Bauteilhöhe [mm],

k_{ax} die Anschlusssteifigkeit zwischen Gewindestange oder Schraube und Holzbauteil [N/mm³],

$k_{ax} = 5$ N/mm³ für Gewindestangen $d = 16$ mm, $k_{ax} = 12,5$ N/mm³ für selbstbohrende Schrauben $d = 8$ mm,

a_1 der Abstand parallel zur Faserrichtung der Gewindestangen oder Schrauben in einer Reihe [mm], für n parallele Reihen kann ein effektiver Abstand von $a_{1,ef} = a_1/n$ verwendet werden

EA_s die axiale Steifigkeit einer Gewindestange oder Schraube [N],

$$EA_s = \frac{E \cdot \pi \cdot d_2^2}{4} = 165.000 d_2^2,$$

d_2 der Kerndurchmesser der Gewindestange oder Schraube [mm],

$d_2 = 12$ mm für Gewindestangen $d = 16$ mm, $d_2 = 5$ mm für Schrauben $d = 8$ mm.

Die axiale Tragfähigkeit einer Gewindestange oder Schraube muss die folgende Bedingung erfüllen:

$$\frac{F_{ax,d}}{F_{ax,Rd}} \leq 1$$

Dabei ist: $F_{ax,Rd}$ das Minimum der Bemessungswerte des Ausziehtragfähigkeit und der Zugtragfähigkeit der Verstärkungsschrauben oder -gewindestangen. Die effektive Eindringtiefe beträgt 50 % der Gewindelänge [N].

Außerhalb der verstärkten Bereiche (getönter Bereich in Abbildung E.1) muss die Schubbemessung die Bedingungen für unverstärkte Bauteile erfüllen.



Abbildung E.1: Holzbauteil mit Schubverstärkung; getönte Bereiche: verstärkte Bereiche mit Schrauben in einem Winkel unter 45°

Anhang F Befestigung von Aufdach-Dämmsystemen

SPAX Schrauben mit einem Gewindeaußendurchmesser von $6 \text{ mm} \leq d \leq 12 \text{ mm}$ können für die Befestigung von Wärmedämmmaterialien auf Sparren verwendet werden.

Die Dicke der Dämmung darf 400 mm nicht überschreiten. Die Aufdach-Dämmung muss auf Sparren aus Vollholz, Brettschichtholz oder Brettspertholz angebracht und mit Konterlatten parallel zu den Sparren oder mit Holzwerkstoffplatten auf der Dämmschicht fixiert werden. Auch die Dämmung von vertikalen Fassaden fällt in den Geltungsbereich der vorliegenden Bestimmungen.

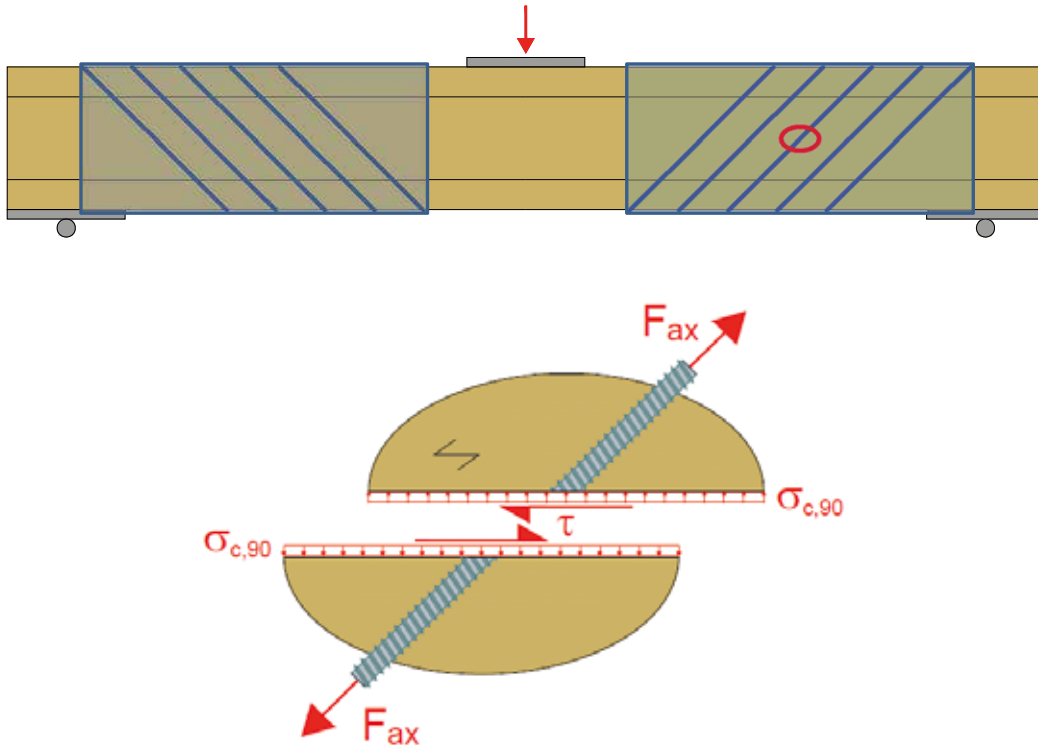
Schrauben müssen ohne Vorbohren in einem Durchgang durch die Konterlatten oder -platten in die Sparren und die Dämmung geschraubt werden.

Der Winkel α der Schraubenachse und der Faserrichtung des Sparrens sollte zwischen 30° und 90° betragen.

Der Sparren muss aus Vollholz (Nadelholz) gemäß EN 338, Brettschichtholz gemäß EN 14081, Brettspertholz, Furnierschichtholz LVL gemäß EN 14374 oder Europäischer Technischer Bewertung oder ähnlich verleimten Holzbauteilen gemäß Europäischer Technischer Bewertung bestehen und eine Mindestbreite von 60 mm haben.

Die Konterlatten müssen aus Vollholz (Nadelholz) gemäß EN 338:2003-04 bestehen. Für die Konterlatten gelten folgende Mindestdicken t und Mindestbreiten b :

Schrauben $d \leq 8,0 \text{ mm}$:	$b_{\min} = 50 \text{ mm}$	$t_{\min} = 30 \text{ mm}$
Schrauben $d = 10 \text{ mm}$:	$b_{\min} = 60 \text{ mm}$	$t_{\min} = 40 \text{ mm}$
Schrauben $d = 12 \text{ mm}$:	$b_{\min} = 80 \text{ mm}$	$t_{\min} = 100 \text{ mm}$

Alternativ zu den Konterlatten können auch Platten mit einer Mindestdicke von 20 mm aus Sperrholz gemäß EN 636, Spanplatten gemäß EN 312, Grospanplatten OSB/3 und OSB/4 gemäß EN 300 oder Europäischer Technischer Zulassung und Vollholzplatten gemäß EN 13353 verwendet werden. Das gilt nur bei parallel geneigten Schrauben.

Die Dämmung muss der Europäischen Technischen Bewertung entsprechen.

Reibungskräfte werden bei der Bemessung des charakteristischen Werts der axialen Tragfähigkeit der Schrauben nicht berücksichtigt.

Die Aufnahme von Windsogkräften sowie die Biegebelastungen der Latten bzw. Platten werden bei der Bemessung berücksichtigt. Falls erforderlich, können zusätzliche Schrauben quer zur Faserrichtung des Sparrens (Winkel $\alpha = 90^\circ$) angebracht werden.

Der maximale Schraubenabstand beträgt $e_{\text{Ser}} = 1,75 \text{ m}$.

Auslegung der Konterlatten

Die Biegebelastungen werden wie folgt berechnet:

$$M = \frac{(F_b + F_s) \cdot \ell_{\text{char}}}{4}$$

Dabei ist

ℓ_{char} = charakteristische Länge

$$\ell_{\text{char}} = \sqrt[4]{\frac{4 \cdot EI}{w_{\text{ef}} \cdot K}}$$

EI = Biegesteifigkeit der Konterlatte [Nmm²]

K = Bettungsziffer [N/mm³]

w_{ef} = effektive Breite des Wärmedämmmaterials [mm]

F_b = Punktbelastungen quer zu den Konterlatten [N]

F_s = Punktbelastungen quer zu den Konterlatten, Lasteintragung im Bereich der Schraubenköpfe [N]

Die Bettungsziffer K kann anhand des Elastizitätsmoduls E_{HI} und der Dicke t_{HI} des Wärmedämmmaterials berechnet werden, wenn die effektive Breite w_{ef} des Wärmedämmmaterials unter Druck bekannt ist. Aufgrund der Ausdehnung des Wärmedämmmaterials unter Druck ist die effektive Breite w_{ef} größer als die Breite der Konterlatte bzw. des Sparrens. Für weitere Berechnungen kann die effektive Breite w_{ef} des Wärmedämmmaterials wie folgt bestimmt werden:

$$w_{\text{ef}} = w + t_{\text{HI}} / 2$$

Dabei ist

w = Mindestbreite der Konterlatte bzw. des Sparrens [mm]

t_{HI} = Dicke des Wärmedämmmaterials [mm]

$$K = \frac{E_{\text{HI}}}{t_{\text{HI}}}$$

Die folgende Bedingung muss erfüllt sein:

$$\frac{\sigma_{\text{m,d}}}{f_{\text{m,d}}} = \frac{M_{\text{d}}}{W \cdot f_{\text{m,d}}} \leq 1$$

Für die Berechnung des Widerstandsmoments W muss der Nettoquerschnitt berücksichtigt werden.

Die Scherbelastungen werden wie folgt berechnet:

$$V = \frac{(F_b + F_s)}{2}$$

Die folgende Bedingung muss erfüllt sein:

$$\frac{\tau_{\text{d}}}{f_{\text{v,d}}} = \frac{1,5 \cdot V_{\text{d}}}{A \cdot f_{\text{v,d}}} \leq 1$$

Für die Berechnung der Querschnittsfläche muss der Nettoquerschnitt berücksichtigt werden.

Auslegung des Wärmedämmmaterials

Die Druckbelastungen des Wärmedämmmaterials werden wie folgt berechnet:

$$\sigma = \frac{1,5 \cdot F_b + F_s}{2 \cdot \ell_{\text{char}} \cdot w}$$

Der Bemessungswert der Druckbelastung darf nicht größer sein als 110 % der Druckbelastung bei einer Deformation von 10 %, berechnet gemäß EN 826.

Auslegung der Schrauben

Die Schrauben werden überwiegend axial belastet. Die axiale Zugkraft in der Schraube kann anhand der Scherbelastungen des Daches R_s berechnet werden:

$$T_s = \frac{R_s}{\cos \alpha}$$

Die Zugtragfähigkeit der Schrauben ist der Mindestbemessungswert des axialen Ausziehwidestands des Gewindeteils der Schraube, des Kopfdurchziehwidestands der Schraube und der Zugtragfähigkeit der Schraube. Um die Deformation des Schraubenkopfes bei einer Dicke des Wärmedämmmaterials von über 200 mm bzw. bei einer Druckspannung unter 0,12 N/mm² zu begrenzen, muss der axiale Ausziehwidestand der Schrauben um die Faktoren k_1 und k_2 reduziert werden:

$$F_{ax,\alpha,Rd} = \min \left\{ \frac{f_{ax,d} \cdot d \cdot \ell_{ef} \cdot k_1 \cdot k_2}{1,2 \cdot \cos^2 \alpha + \sin^2 \alpha} \cdot \left(\frac{\rho_k}{350} \right)^{0,8}; f_{head,d} \cdot d_h^2 \cdot \left(\frac{\rho_k}{350} \right)^{0,8}; \frac{f_{tens,k}}{\gamma_{M2}} \right\} \quad \text{für SPAX Schrauben mit Teilgewinde}$$

$$F_{ax,\alpha,Rd} = \min \left\{ \max \left\{ \frac{f_{ax,d} \cdot d \cdot \ell_{ef} \cdot k_1 \cdot k_2}{1,2 \cdot \cos^2 \alpha + \sin^2 \alpha} \cdot \left(\frac{\rho_k}{350} \right)^{0,8}; f_{head,d} \cdot d_h^2; \frac{f_{ax,d} \cdot d \cdot \ell_{ef,b} \cdot k_1 \cdot k_2}{1,2 \cdot \cos^2 \alpha + \sin^2 \alpha} \cdot \left(\frac{\rho_k}{350} \right)^{0,8} \right\}; \frac{f_{tens,k}}{\gamma_{M2}} \right\} \quad \text{für SPAX Schrauben mit Voll- oder Doppelgewinde}$$

Dabei ist:

- $f_{ax,d}$ der Bemessungswert des axialen Ausziehparameters des Gewindeteils der Schraube [N/mm²]
- d der Gewindeaußendurchmesser der Schraube [mm] (d_1 in den Zeichnungen im Anhang)
- ℓ_{ef} die Einschraubtiefe des Gewindeteils der Schraube in den Sparren [mm], $\ell_{ef} \geq 40$ mm
- $\ell_{ef,b}$ die Einschraubtiefe des Gewindeteils der Schraube in die Konterlatte [mm]
- α der Winkel zwischen Faserrichtung und Schraubenachse [°] ($\alpha \geq 30^\circ$)
- ρ_k die charakteristische Rohdichte des Holzbauteils [kg/m³]
- $f_{head,d}$ der Bemessungswert des Kopfdurchziehtragfähigkeit der Schraube [N/mm²]
- d_h Kopfdurchmesser [mm] (d_k in den Zeichnungen im Anhang)
- $f_{tens,k}$ die charakteristische Zugtragfähigkeit der Schraube [N]
- γ_{M2} der Teilsicherheitsbeiwert gemäß EN 1993-1-1 oder des jeweiligen nationalen Anhangs
- k_1 $\min \{1; 200/t_{HI}\}$
- k_2 $\min \{1; \sigma_{10\%}/0,12\}$
- t_{HI} die Dicke des Wärmedämmmaterials [mm]
- $\sigma_{10\%}$ die Druckspannung des Wärmedämmmaterials bei einer Stauchung von 10 % [N/mm²]

Wenn k_1 und k_2 berücksichtigt werden, muss die Durchbiegung der Konterlatten nicht berücksichtigt werden. Alternativ zu den Konterlatten können auch Platten mit einer Mindestdicke von 20 mm aus Sperrholz gemäß EN 636, einer ETA oder am Installationsort geltenden nationalen Bestimmungen, Spanplatten gemäß EN 312, einer ETA oder am Installationsort geltenden nationalen Bestimmungen, Grobspanplatten gemäß EN 300, einer ETA oder am Installationsort geltenden nationalen Bestimmungen, Vollholzplatten gemäß EN 13353, einer ETA oder am Installationsort geltenden nationalen Bestimmungen oder Brettsperrholz gemäß ETA verwendet werden.

Wärmedämmmaterial auf Sparren mit alternierend geneigten Schrauben

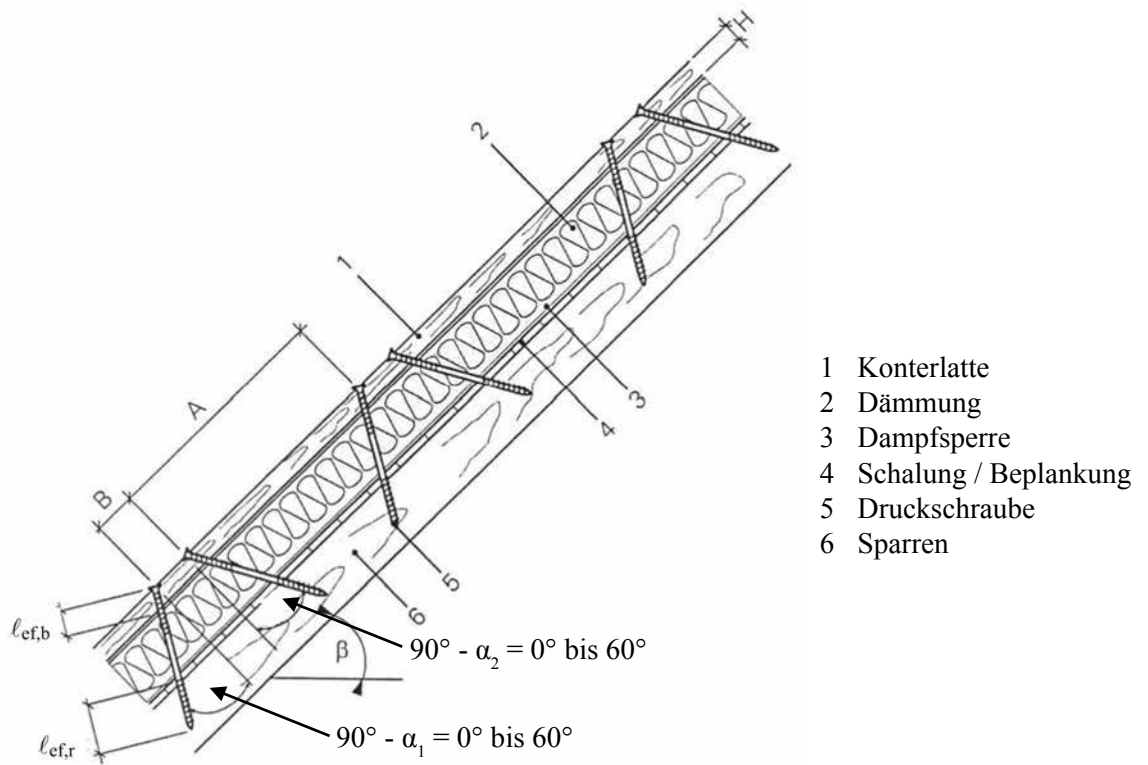

- 1 Konterlatte
- 2 Dämmung
- 3 Dampfsperre
- 4 Schalung / Beplankung
- 5 Druckschraube
- 6 Sparren

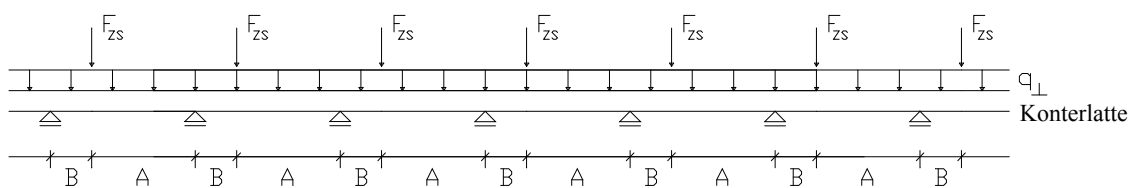

Mechanisches Modell

Je nach Schraubenabstand und Anordnung der Zug- und Druckschrauben mit verschiedenen Neigungen werden die Latten mit erheblichen Biegemomenten belastet. Diese Biegemomente auf der Grundlage der folgenden Annahmen abgeleitet werden:

- Die Zug- und Druckbelastungen in den Schrauben werden auf der Grundlage der Gleichgewichtsbedingungen der Wirkungen parallel und quer zur Dachebene bestimmt.
Dabei handelt es sich um die konstanten Streckenlasten q_{\perp} und q_{\parallel} .
- Die Schrauben fungieren als Pendelstützen, welche 10 mm in der Latte bzw. im Sparren eingebunden sind. Die effektive Stützenlänge entspricht demnach der Länge der Schrauben zwischen Latte und Sparren plus 20 mm.
- Die Latte gilt als durchlaufender Balken mit einer konstanten Spannweite $\ell = A + B$.
Die Druckschrauben unterstützen den durchlaufenden Balken, während die Zugschrauben die konzentrierten Belastungen quer zur Achse der Latte übertragen.

Die Schrauben stehen vorwiegend unter Auszieh- bzw. Druckbelastung. Die Normalkräfte der Schraube werden auf der Grundlage der Belastungen parallel und quer zur Dachebene bestimmt:

$$\text{Druckschraube: } F_{c,Ed} = (A+B) \cdot \left(-\frac{q_{\parallel}}{\cos \alpha_1 + \sin \alpha_1 / \tan \alpha_2} - \frac{q_{\perp} \cdot \sin (90^{\circ} - \alpha_2)}{\sin (\alpha_1 + \alpha_2)} \right)$$

$$\text{Zugschraube: } F_{t,Ed} = (A+B) \cdot \left(\frac{q_{\parallel}}{\cos \alpha_2 + \sin \alpha_2 / \tan \alpha_1} - \frac{q_{\perp} \cdot \sin (90^{\circ} - \alpha_1)}{\sin (\alpha_1 + \alpha_2)} \right)$$

Die Biegemomente in der Latte entstehen aus der konstanten Streckenlast q_{\perp} und den Lastkomponenten quer zur Latte durch die Zugschrauben. Die Spannweite des durchlaufenden Trägers beträgt $(A + B)$. Die Lastkomponente quer zur Latte durch die Zugschraube beträgt:

$$F_{ZS,Ed} = (A + B) \cdot \left(\frac{q_{\parallel}}{1/\tan \alpha_1 + 1/\tan \alpha_2} - \frac{q_{\perp} \cdot \sin(90^\circ - \alpha_1) \cdot \sin \alpha_2}{\sin(\alpha_1 + \alpha_2)} \right)$$

Dabei ist:

- q_{\parallel} die konstante Streckenlast parallel zur Latte [N/mm]
- q_{\perp} die konstante Streckenlast quer zur Latte [N/mm]
- α_1 der Winkel zwischen der Achse der Druckschraube und der Faserrichtung
- α_2 der Winkel zwischen der Achse der Zugschraube und der Faserrichtung

Ein positiver Wert für F_{ZS} bedeutet eine Belastung in Richtung des Sparrens, ein negativer Wert eine Belastung weg vom Sparren.

Auslegung der Schrauben

Die Tragfähigkeit der Schrauben wird wie folgt berechnet:

Schrauben unter Zugbelastung:

$$F_{ax,\alpha,Rd} = \min \left\{ \frac{f_{ax,d} \cdot d \cdot \ell_{ef,b}}{1,2 \cdot \cos^2 \alpha_2 + \sin^2 \alpha_2} \cdot \left(\frac{\rho_{b,k}}{350} \right)^{0,8}; \frac{f_{ax,d} \cdot d \cdot \ell_{ef,r}}{1,2 \cdot \cos^2 \alpha_2 + \sin^2 \alpha_2} \cdot \left(\frac{\rho_{r,k}}{350} \right)^{0,8}; \frac{f_{tens,k}}{\gamma_{M2}} \right\}$$

Schrauben unter Druckbelastung:

$$F_{ax,\alpha,Rd} = \min \left\{ \frac{f_{ax,d} \cdot d \cdot \ell_{ef,b}}{1,2 \cdot \cos^2 \alpha_1 + \sin^2 \alpha_1} \cdot \left(\frac{\rho_{b,k}}{350} \right)^{0,8}; \frac{f_{ax,d} \cdot d \cdot \ell_{ef,r}}{1,2 \cdot \cos^2 \alpha_1 + \sin^2 \alpha_1} \cdot \left(\frac{\rho_{r,k}}{350} \right)^{0,8}; \frac{\kappa_c \cdot N_{pl,k}}{\gamma_{M1}} \right\}$$

Dabei ist:

- $f_{ax,d}$ der Bemessungswert des axialen Ausziehparameter des Gewindeteils der Schraube [N/mm²]
- d der Gewindeaußendurchmesser der Schraube [mm] (d_1 in den Zeichnungen im Anhang)
- $\ell_{ef,b}$ die Einschraubtiefe des Gewindeteils im Sparren einschließlich Kopf für Zugkraft und ohne Kopf für Druckkraft [mm]
- $\ell_{ef,r}$ die Einschraubtiefe des Gewindeteils der Schraube in den Sparren [mm], $\ell_{ef} \geq 40$ mm
- $\rho_{b,k}$ die charakteristische Rohdichte der Latte [kg/m³]
- $\rho_{r,k}$ die charakteristische Rohdichte des Sparren [kg/m³]
- α der Winkel α_1 oder α_2 zwischen Schraubenachse und Faserrichtung, $30^\circ \leq \alpha_1 \leq 90^\circ$, $30^\circ \leq \alpha_2 \leq 90^\circ$
- $f_{tens,k}$ die charakteristische Zugtragfähigkeit der Schraube [N]
- γ_{M1} , γ_{M2} Teilsicherheitsbeiwerte gemäß EN 1993-1-1 oder des jeweiligen nationalen Anhangs
- $\kappa_c \cdot N_{pl,k}$ die Tragfähigkeit gegen Ausknicken der Schraube [N]

Freie Schrauben- länge [mm]	Kohlenstoffstahl				Edelstahl	
	6,0 mm	8,0 mm	10,0 mm	12,0 mm	10,0 mm	12,0 mm
	$\kappa_c \cdot N_{pl,k}$ [kN]	$\kappa_c \cdot N_{pl,k}$ [kN]	$\kappa_c \cdot N_{pl,k}$ [kN]	$\kappa_c \cdot N_{pl,k}$ [kN]	$\kappa_c \cdot N_{pl,k}$ [kN]	$\kappa_c \cdot N_{pl,k}$ [kN]
≤ 100	1,12	2,79	6,09	14,3	5,22	11,3
120	0,85	2,12	4,68	11,2	4,16	9,37
140	0,66	1,66	3,70	8,98	3,36	7,79
160	0,53	1,34	2,99	7,33	2,76	6,53
180	0,43	1,10	2,48	6,09	2,30	5,52
200		0,92	2,07	5,13	1,94	4,71
220		0,78	1,76	4,38	1,66	4,06
240		0,67	1,51	3,79	1,44	3,53
260		0,58	1,32	3,30	1,26	3,10
280		0,51	1,15	2,90	1,11	2,74
300		0,45	1,02	2,57	0,98	2,44
320		0,40	0,91	2,29	0,88	2,18
340		0,36	0,82	2,06	0,79	1,97
360		0,32	0,73	1,86	0,71	1,78
380		0,29	0,67	1,68	0,65	1,62
400		0,26	0,61	1,53	0,59	1,48
420		0,24	0,55	1,40	0,54	1,36
440		0,22	0,51	1,29	0,49	1,25
460		0,20	0,47	1,19	0,46	1,15
480		0,19	0,43	1,10	0,42	1,06